

B''+ +A''

+ B'

+ C'

+ A'

U7

Sistema dièdric: altres cossos geomètrics

FIGURA
57

EXERCICI
13

NOM

DATA

NOTA

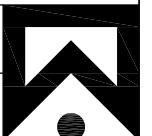

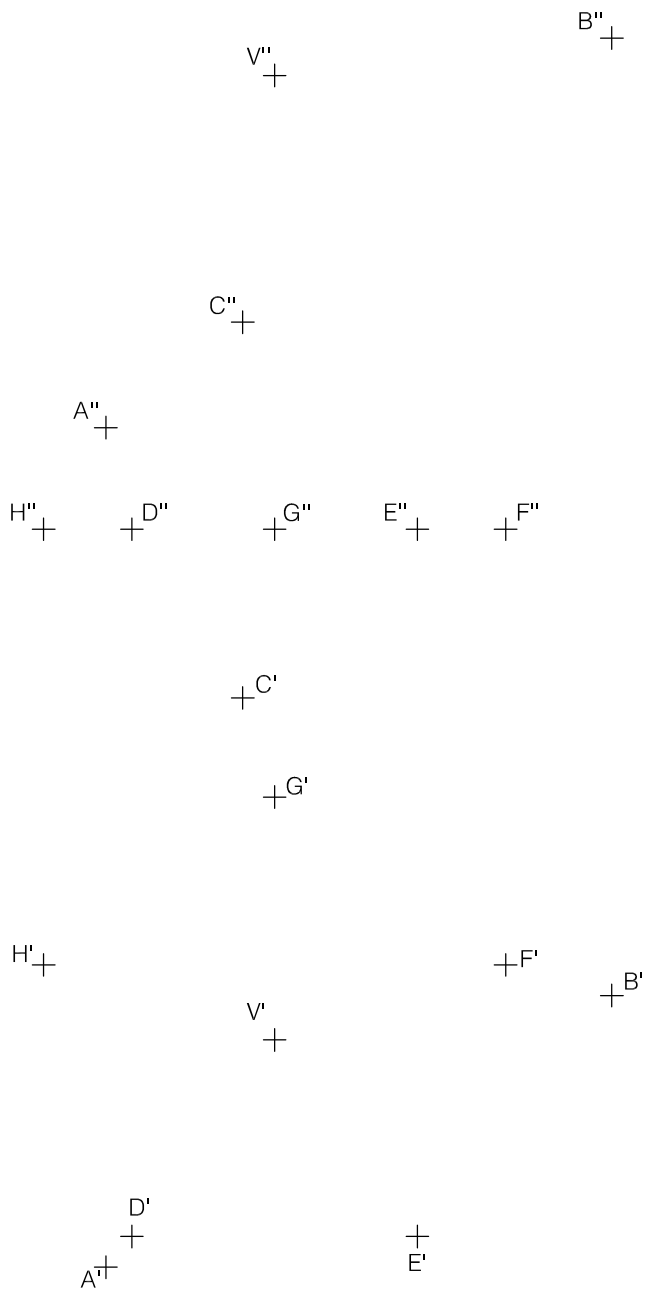

U7	Sistema dièdric: altres cossos geomètrics	FIGURA 58	EXERCICI 14
NOM		DATA	NOTA



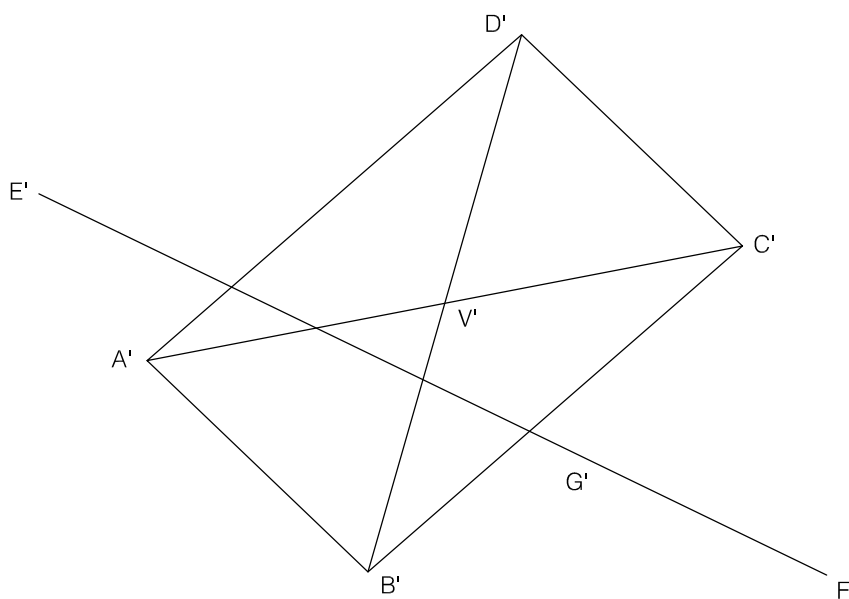
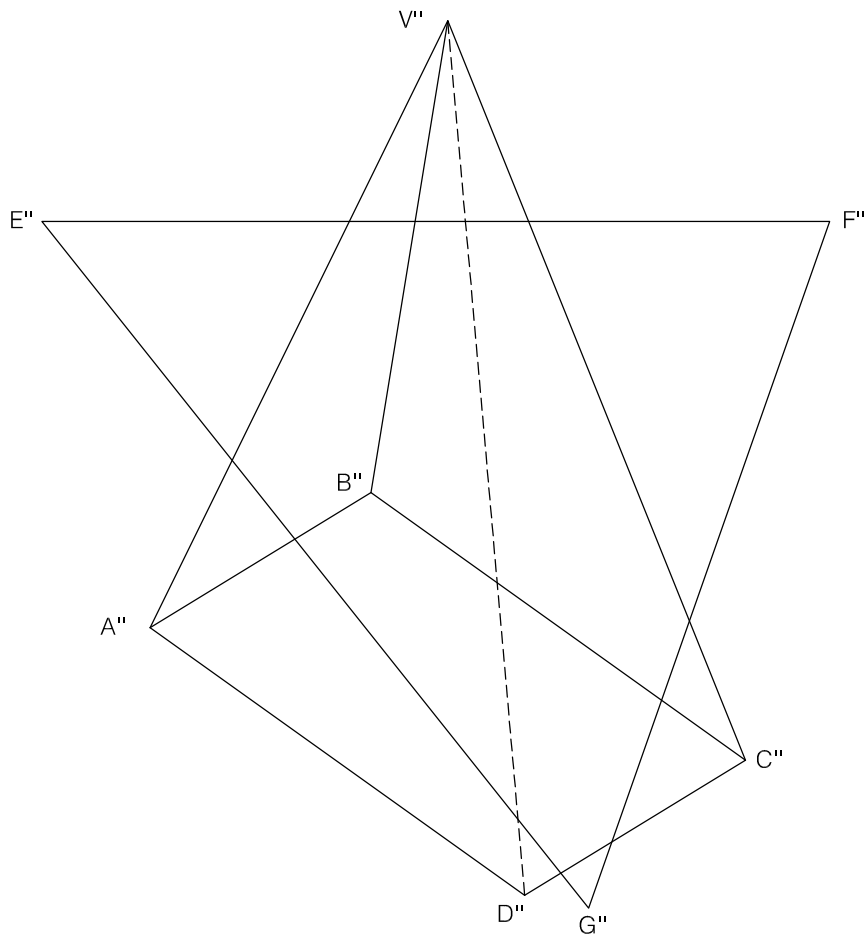

U7	Sistema dièdric: altres cossos geomètrics	FIGURA 59	EXERCICI 15
NOM	DATA	NOTA	

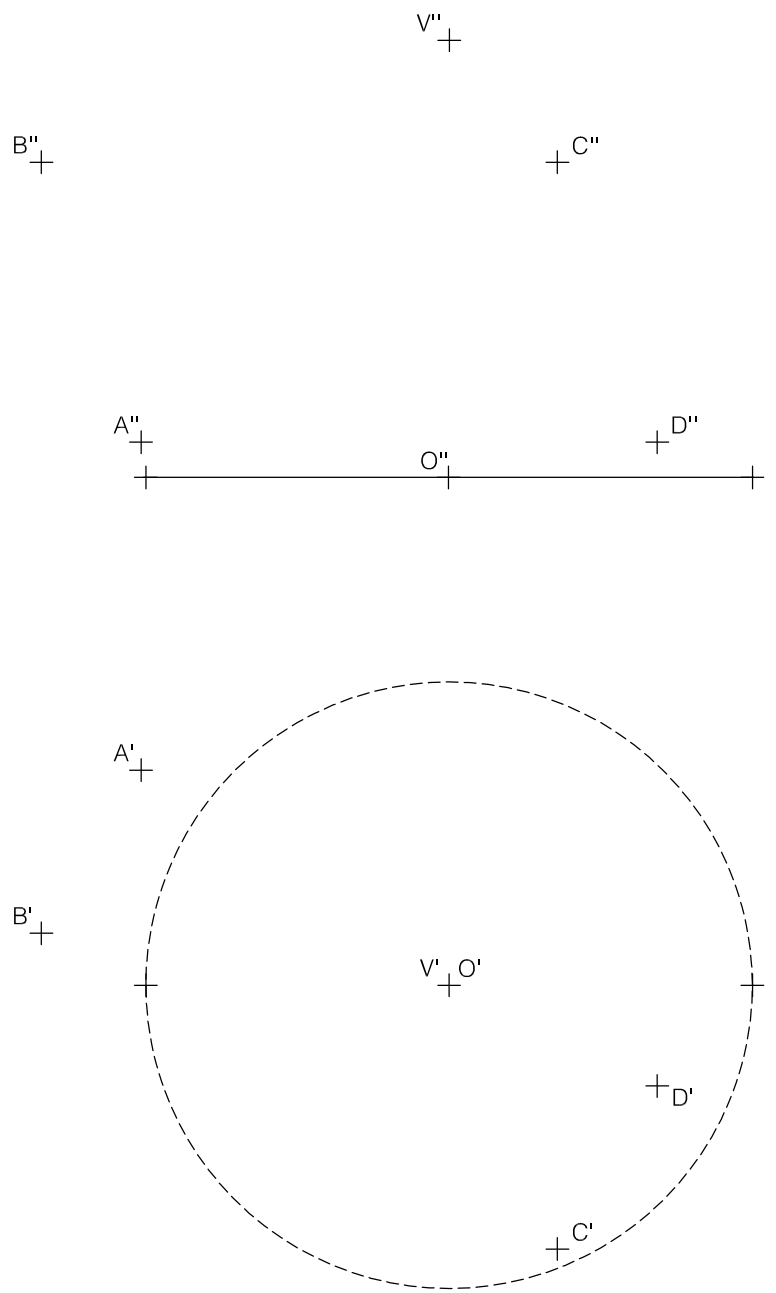

U7	Sistema dièdric: altres cossos geomètrics	FIGURA 60	EXERCICI 16
NOM	DATA	NOTA	



$+A''$
 $C''+$ $+B''$
 $C'+$ $+A'$
 $+B'$

U7

Sistema dièdric: altres cossos geomètrics

FIGURA
61

EXERCICI
17

NOM

DATA

NOTA

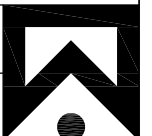

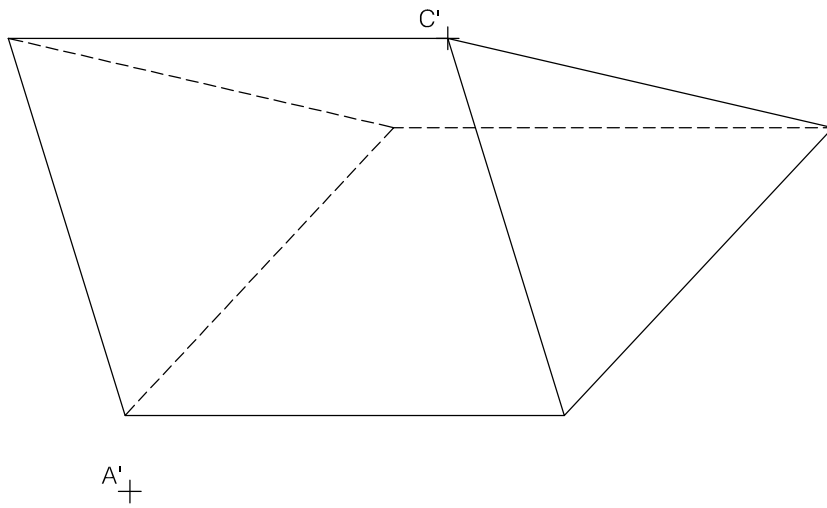
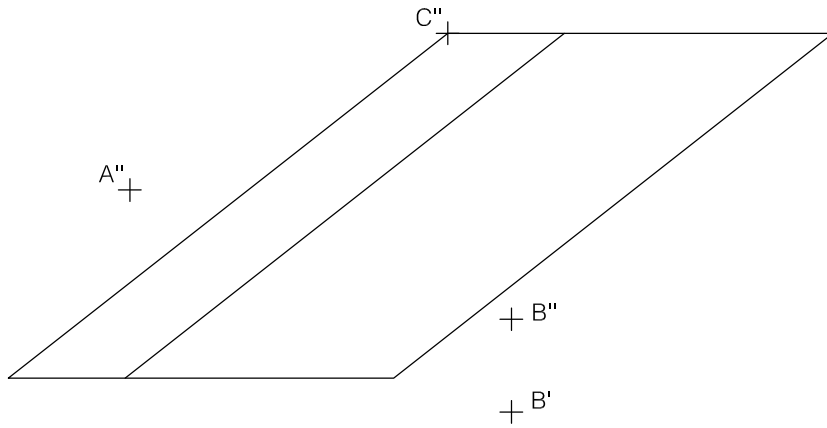

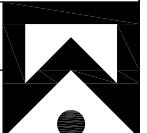

U7	Sistema dièdric: altres cossos geomètrics	FIGURA 62	EXERCICI 18
NOM	DATA	NOTA	

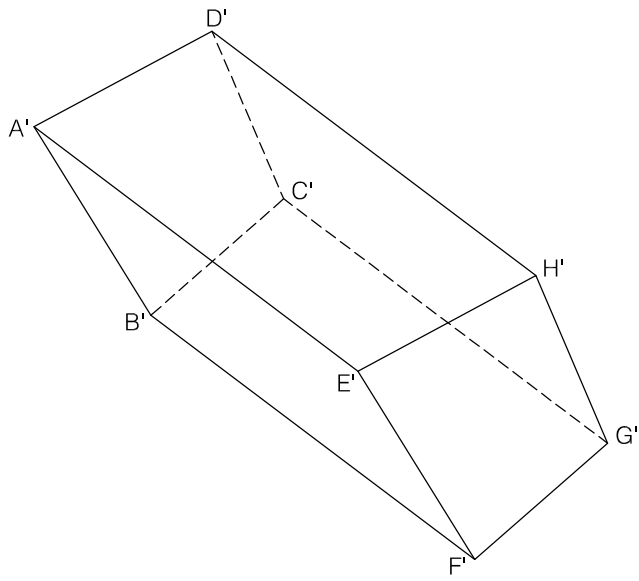
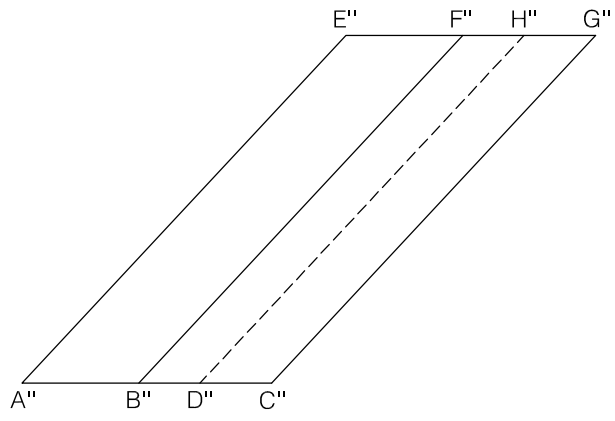

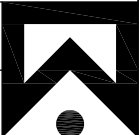

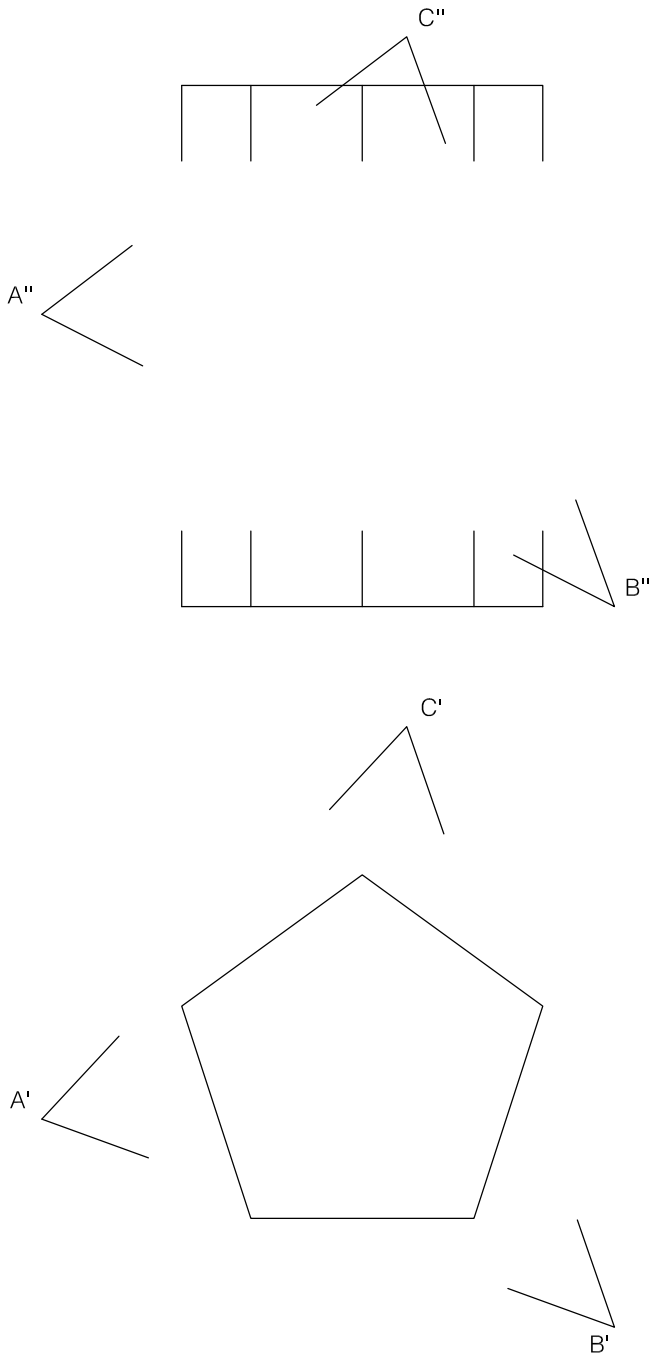
U7	Sistema dièdric: altres cossos geomètrics	FIGURA 63	EXERCICI 19
NOM	DATA	NOTA	



U7	Sistema dièdric: altres cossos geomètrics	FIGURA 64	EXERCICI 20
NOM	DATA	NOTA	

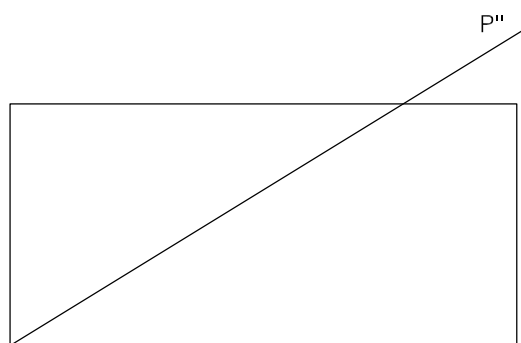

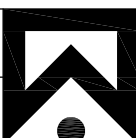
U7	Sistema dièdric: altres cossos geomètrics	FIGURA 65	EXERCICI 21
NOM	DATA	NOTA	

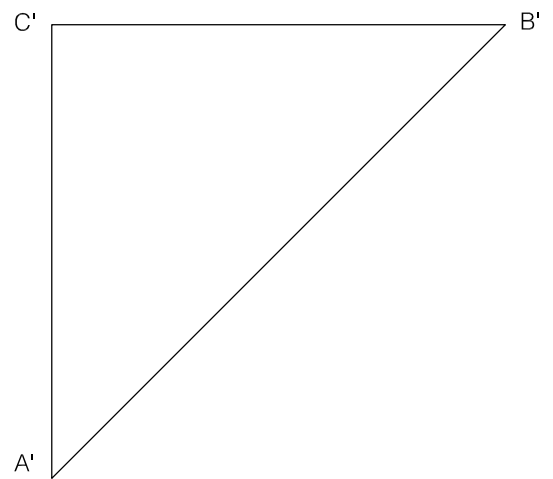
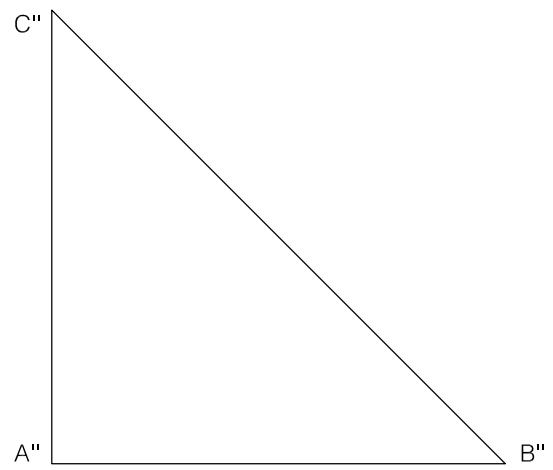

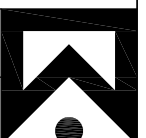
U7	Sistema dièdric: altres cossos geomètrics	FIGURA 66	EXERCICI 22
NOM	DATA	NOTA	

$+V''$

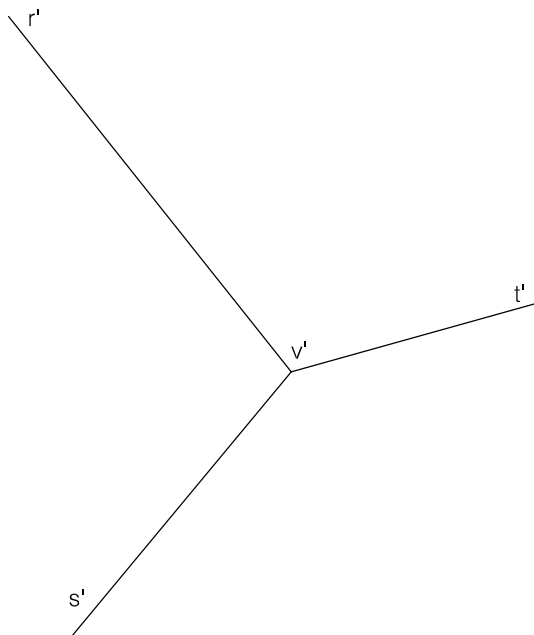

U7

Sistema dièdric: altres cossos geomètrics

FIGURA
67

EXERCICI
23

NOM

DATA

NOTA

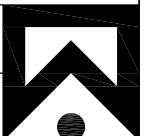

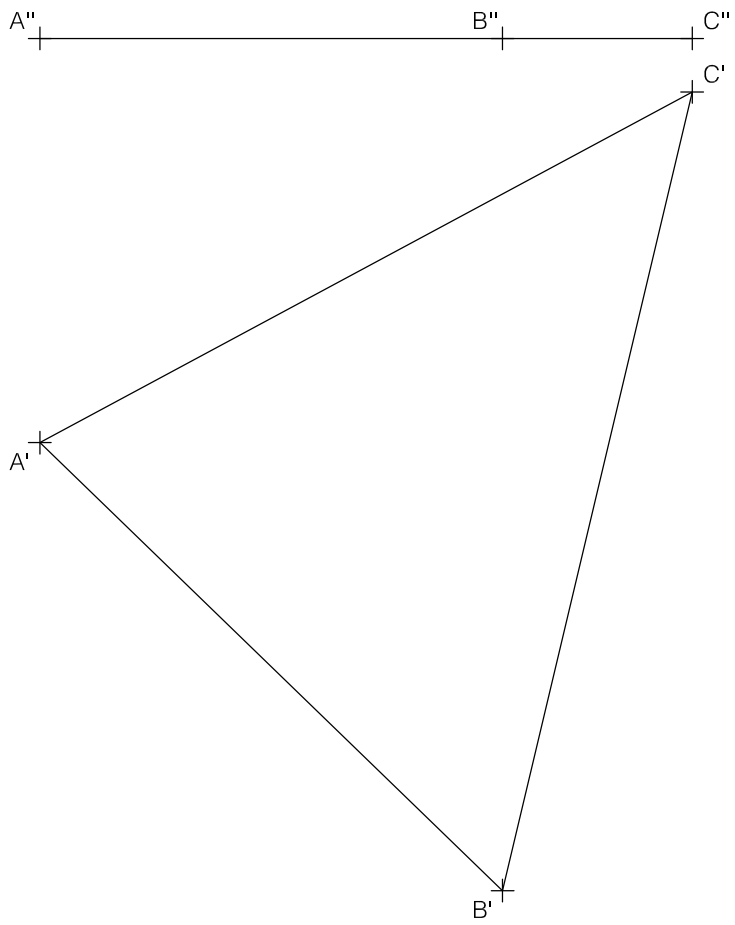

U7	Sistema dièdric: altres cossos geomètrics	FIGURA 68	EXERCICI 24
NOM	DATA	NOTA	