

$A_2''+$

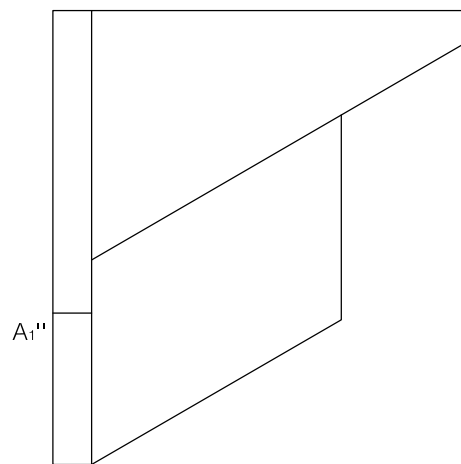

U4	Sistema dièdric: moviments	FIGURA 30	EXERCICI 13
NOM	DATA		NOTA

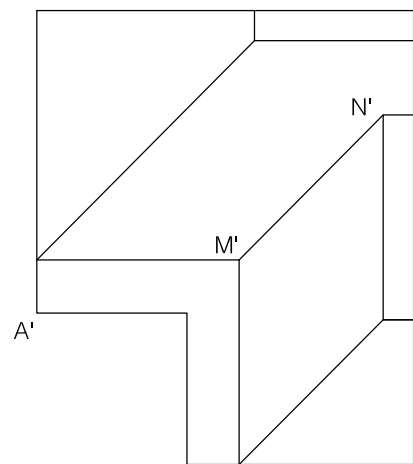
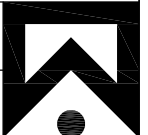

$V_2'$  +

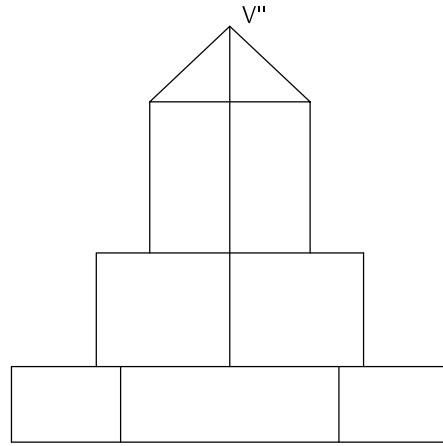

$V_1''$  +

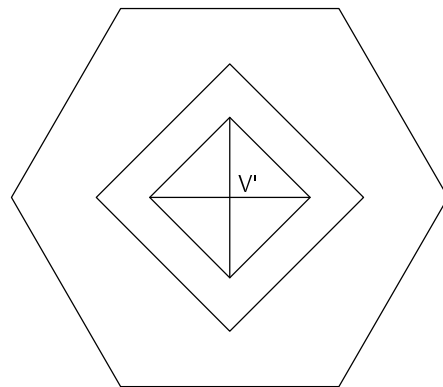

U4

Sistema dièdric: moviments

FIGURA  
31

EXERCICI  
14

NOM

DATA

NOTA

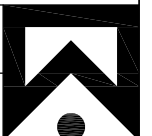

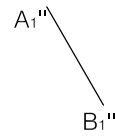
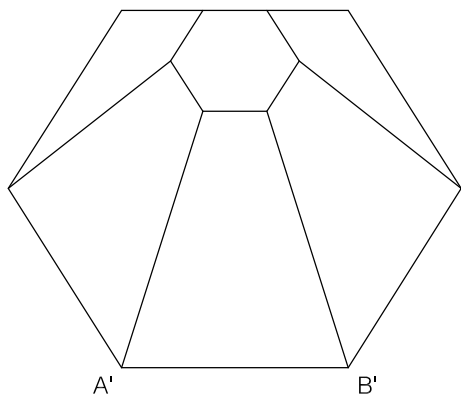
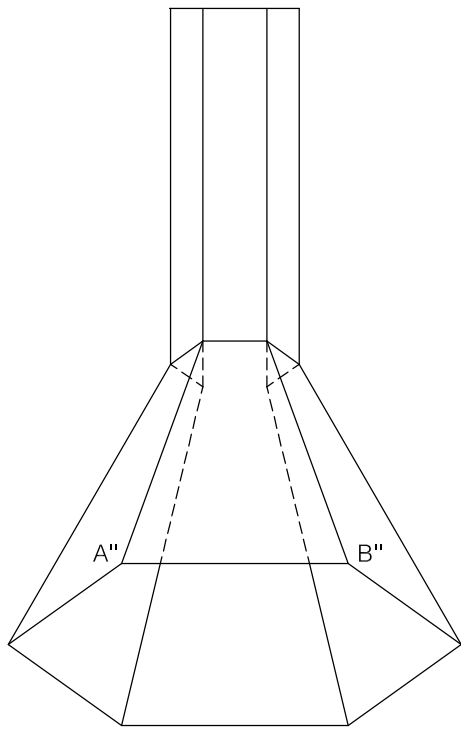

U4	Sistema dièdric: moviments	FIGURA 32	EXERCICI 15
NOM	DATA	NOTA	

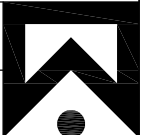

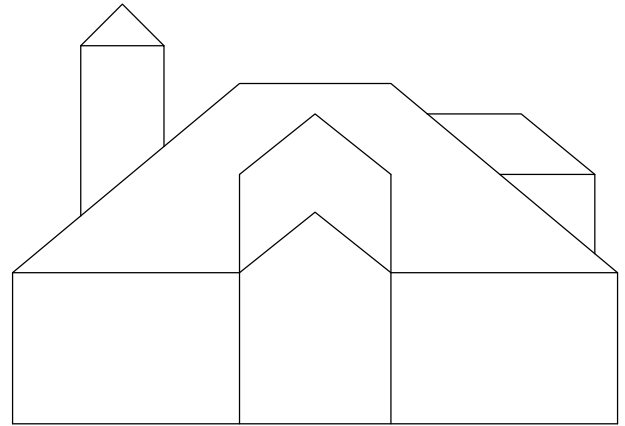

C''

+  
C<sub>1</sub>''

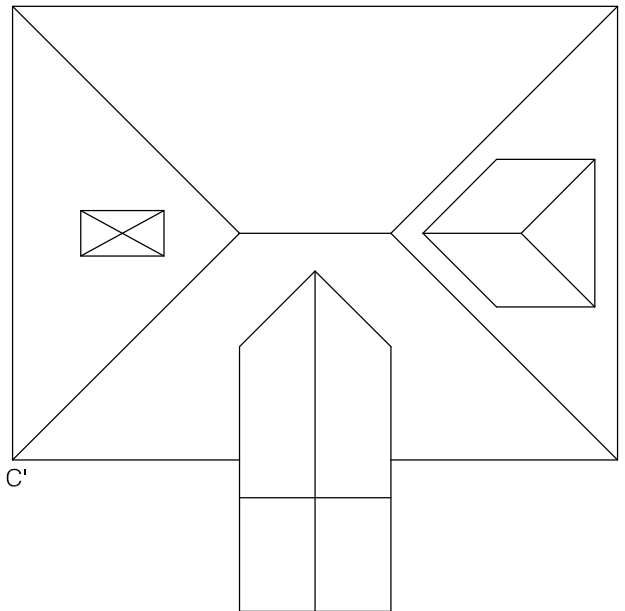

C'

U4

Sistema dièdric: moviments

FIGURA  
33

EXERCICI  
16

NOM

DATA

NOTA

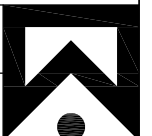

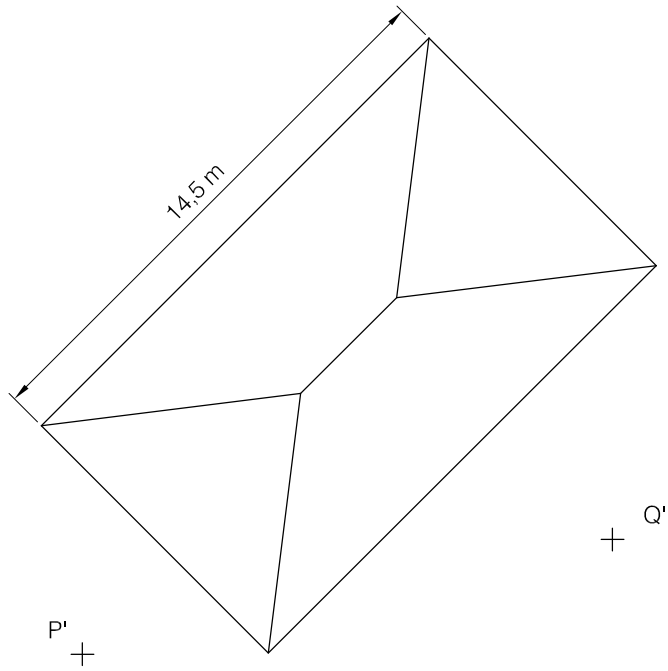
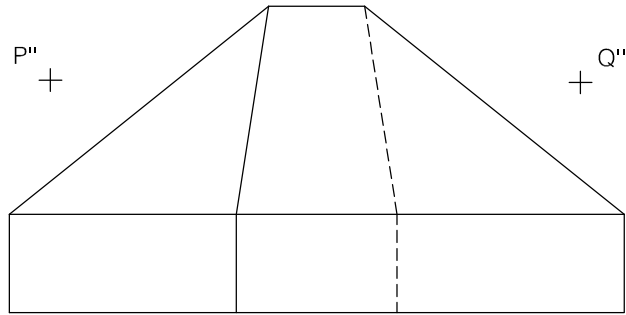

U4	Sistema dièdric: moviments	FIGURA 34	EXERCICI 17
NOM	DATA	NOTA	

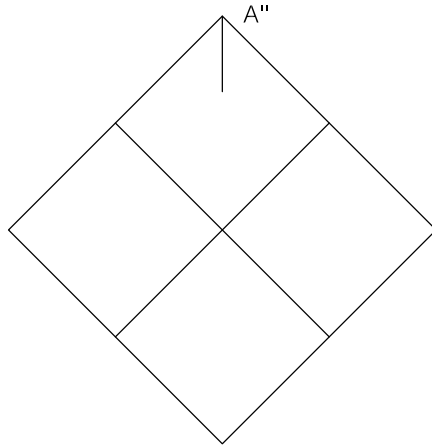

$A_1''$  ↙

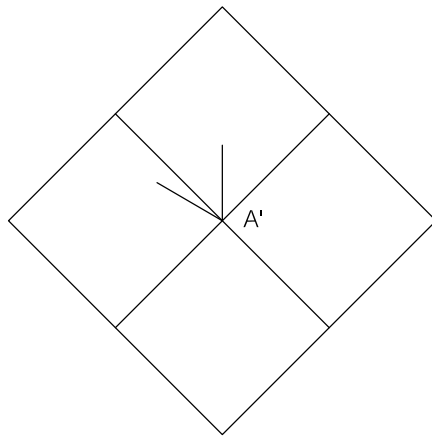

U4	Sistema dièdric: moviments	FIGURA 35	EXERCICI 18
NOM	DATA		NOTA



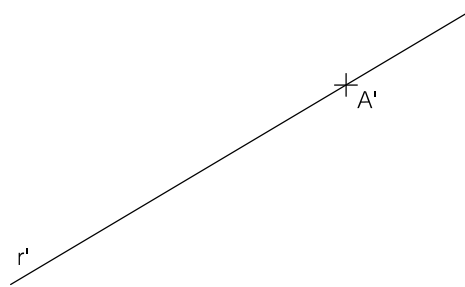
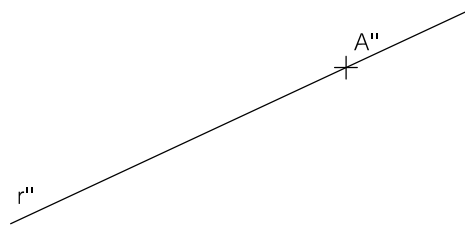

U4	Sistema dièdric: moviments	FIGURA 36	EXERCICI 19
NOM	DATA		NOTA



A'' ————— B''

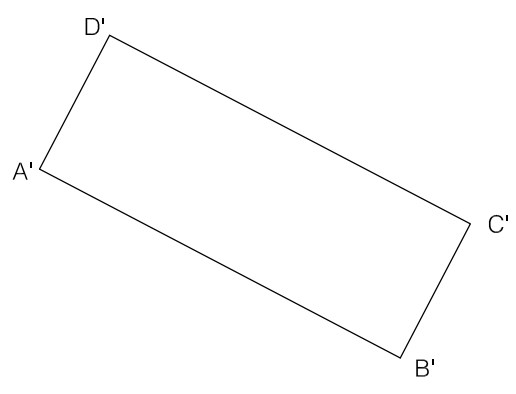

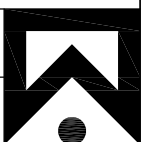
U4	Sistema dièdric: moviments	FIGURA 37	EXERCICI 20
NOM	DATA	NOTA	



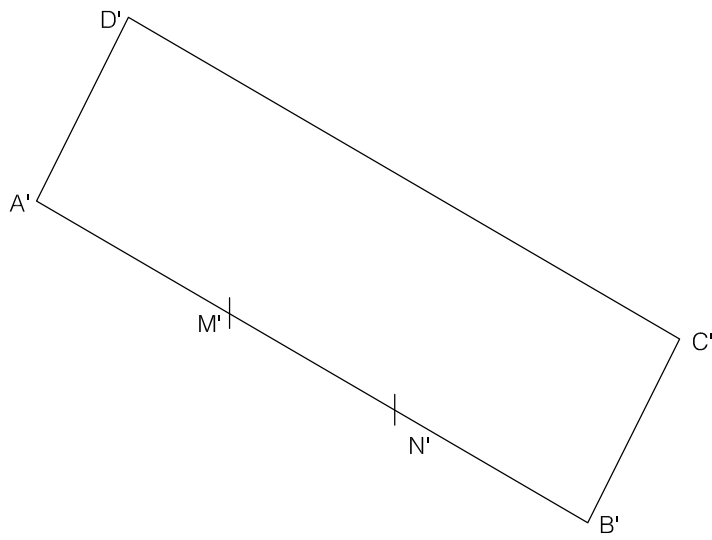
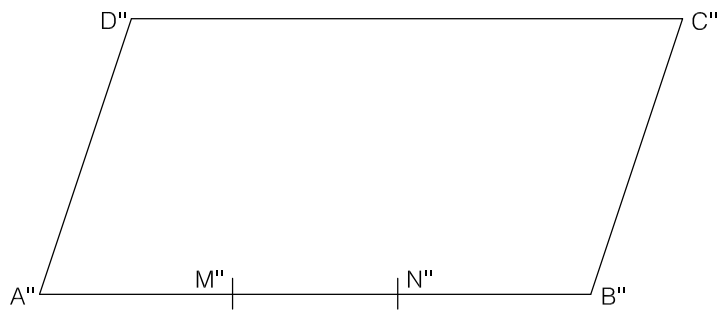

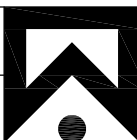
U4	Sistema dièdric: moviments	FIGURA 38	EXERCICI 21
NOM	DATA	NOTA	

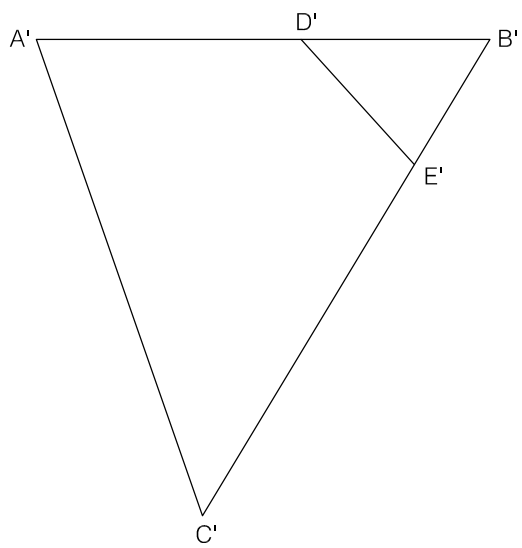
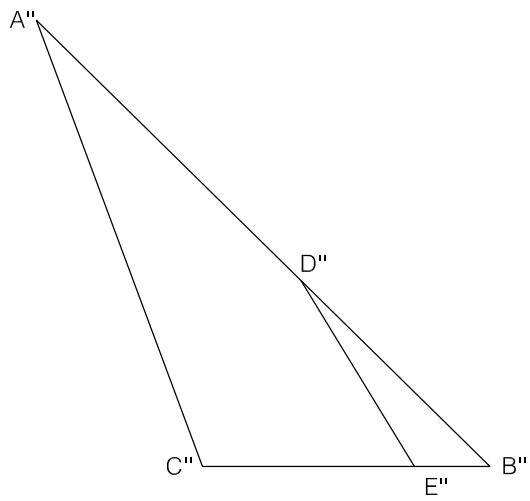

U4	Sistema dièdric: moviments	FIGURA 39	EXERCICI 22
NOM	DATA		NOTA

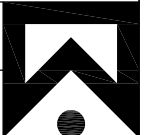

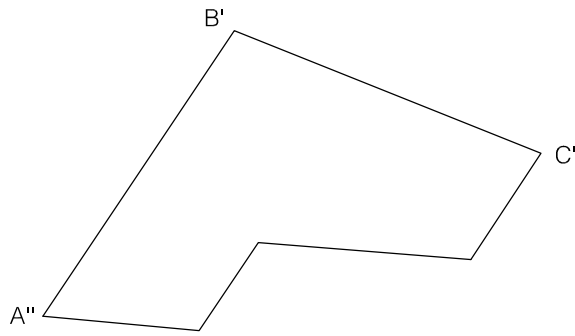
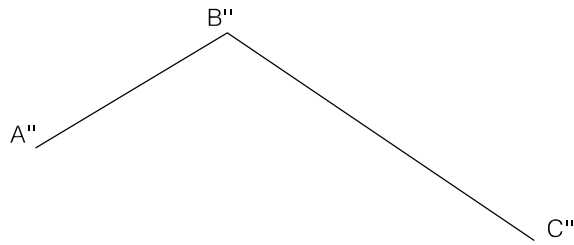

U4	Sistema dièdric: moviments	FIGURA 40	EXERCICI 23	
NOM	DATA		NOTA	

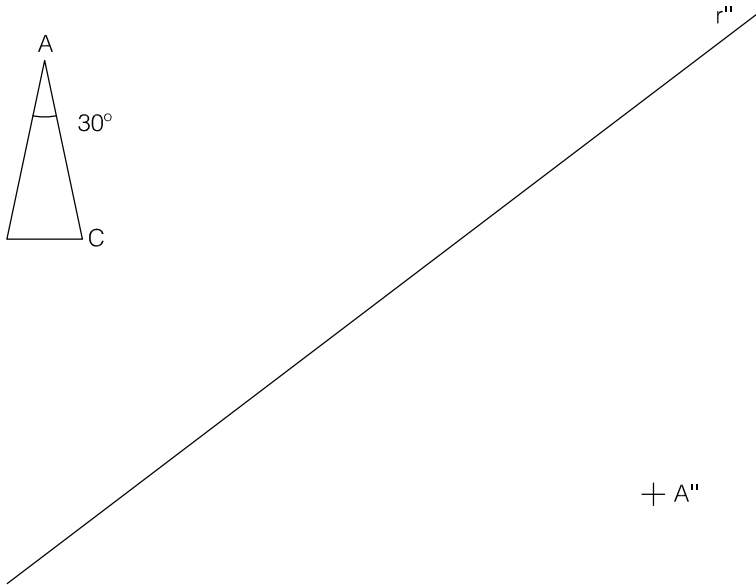
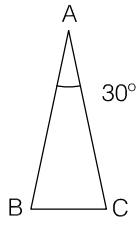

+ A''

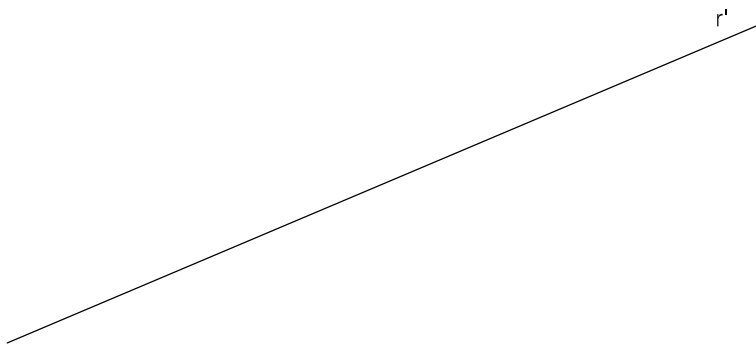

+ A'

U4	Sistema dièdric: moviments	FIGURA 41	EXERCICI 24
NOM	DATA	NOTA	