

+ A

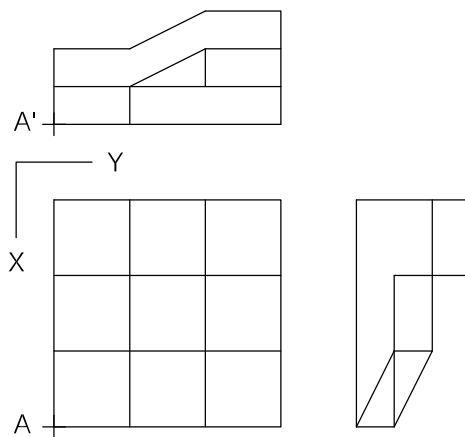
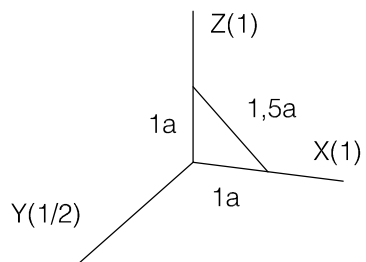

U8

Sistemes axonòmrics i perspectiva cavallera

FIGURA
58

EXERCICI
9

NOM

DATA

NOTA



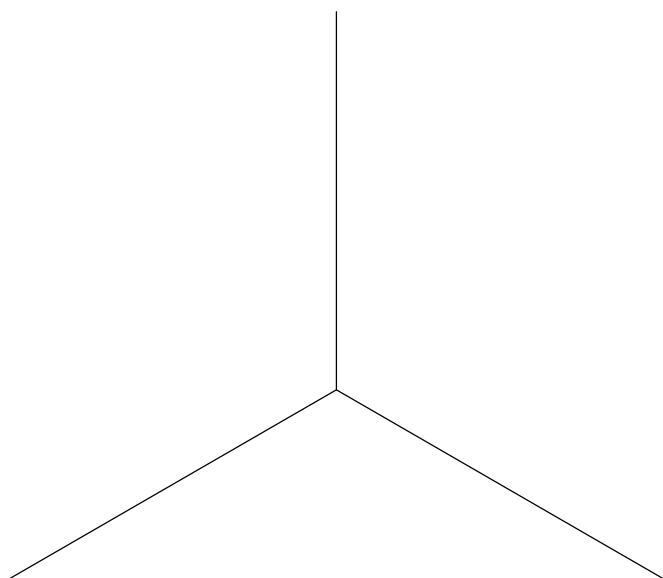
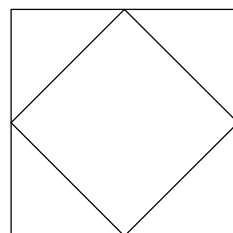
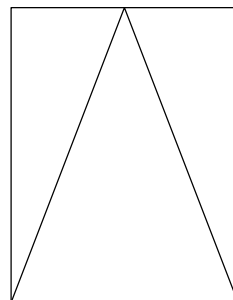
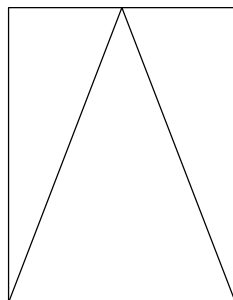

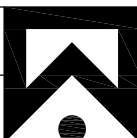
U8	Sistemes axonòmtrics i perspectiva cavallera	FIGURA 59	EXERCICI 10
NOM	DATA	NOTA	

P +

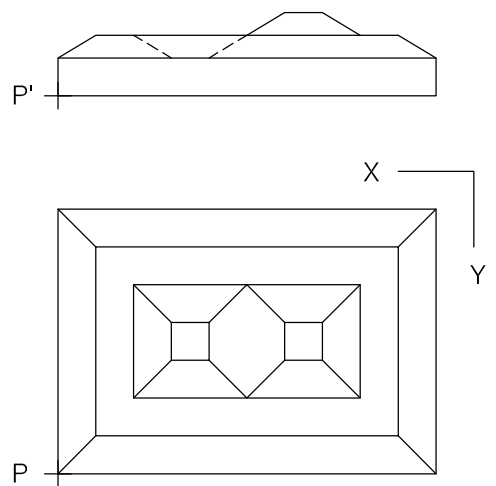
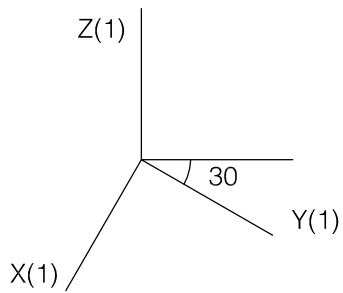

U8

Sistemes axonòmtrics i perspectiva cavallera

FIGURA
60

EXERCICI
11

NOM

DATA

NOTA

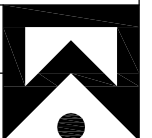

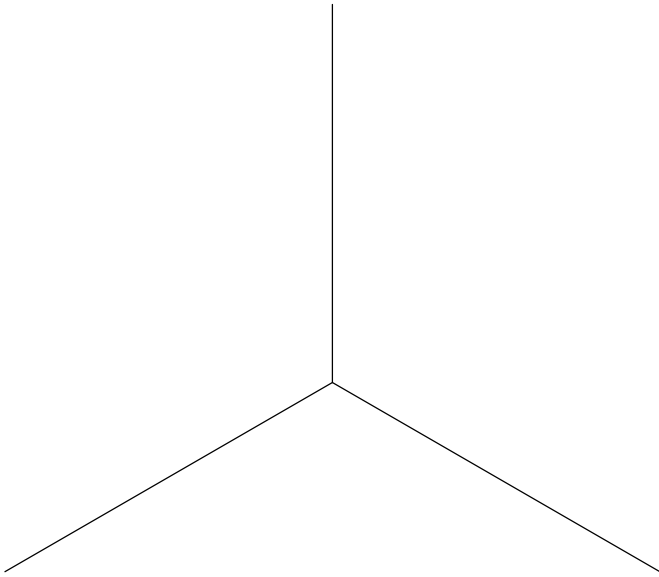
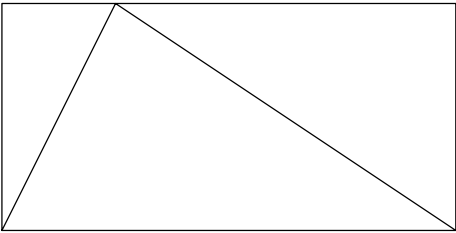
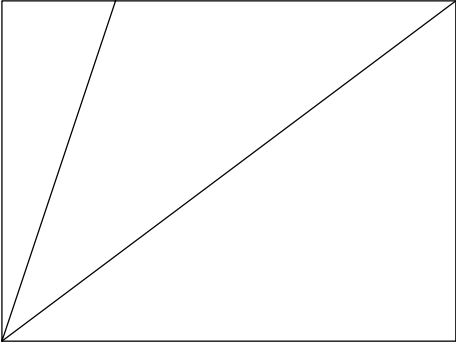

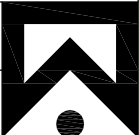
U8	Sistemes axonòmètrics i perspectiva cavallera	FIGURA 61	EXERCICI 12
NOM	DATA	NOTA	

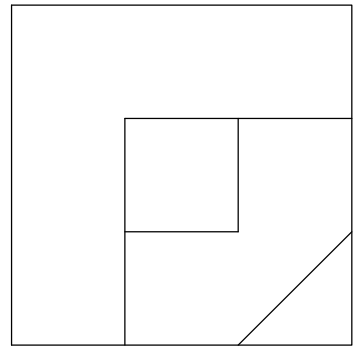
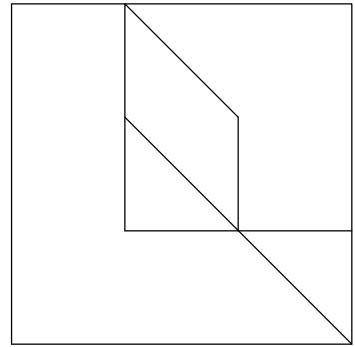
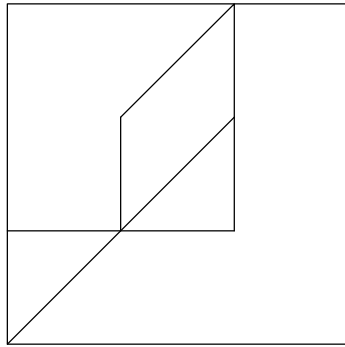

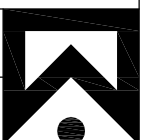

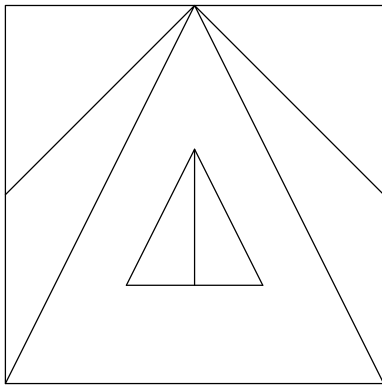
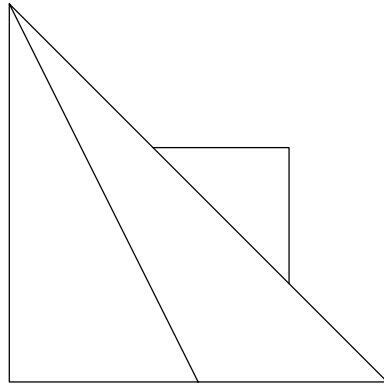
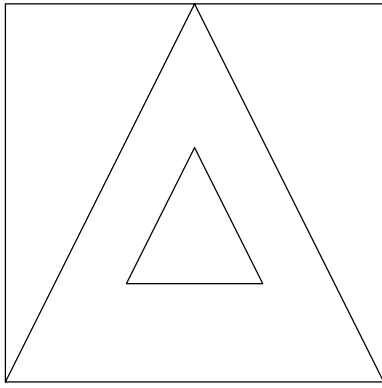
U8	Sistemes axonòmtrics i perspectiva cavallera	FIGURA 62	EXERCICI 13
NOM	DATA	NOTA	



U8	Sistemes axonòmètrics i perspectiva cavallera	FIGURA 63	EXERCICI 14
NOM	DATA		NOTA

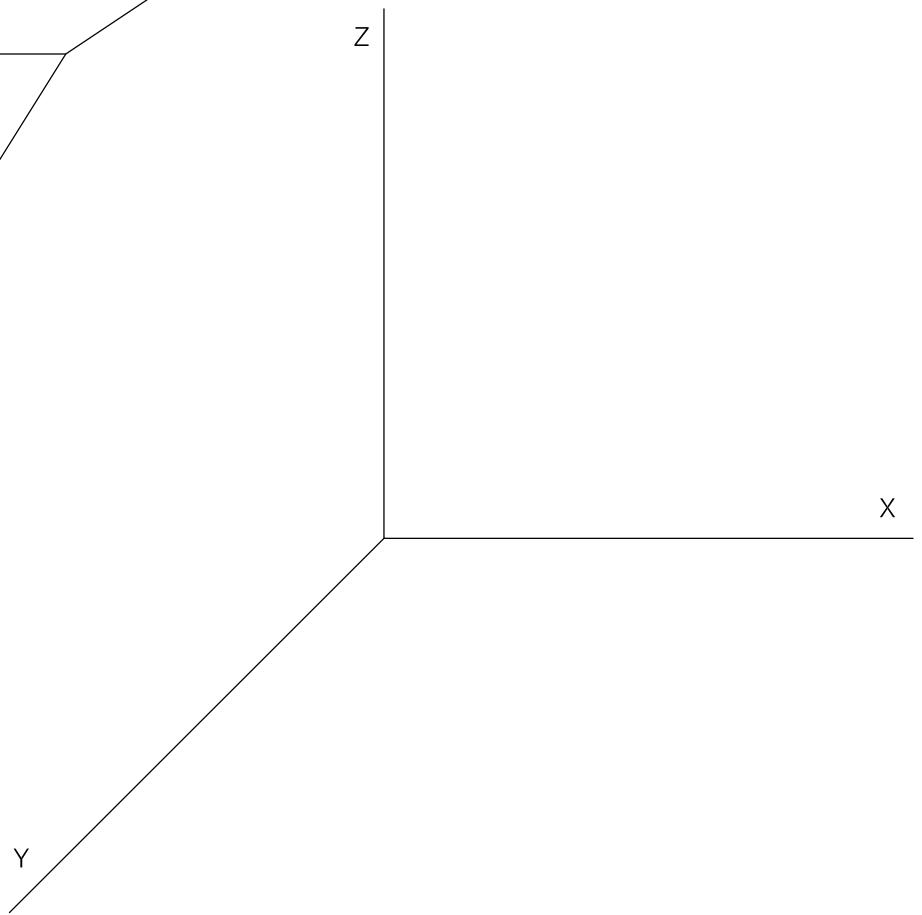
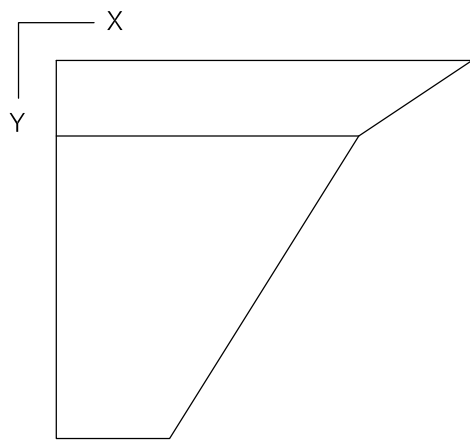
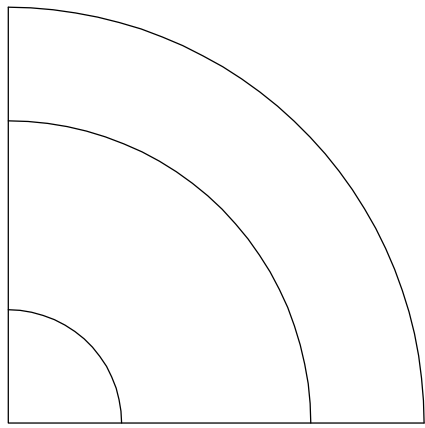



U8	Sistemes axonòmtrics i perspectiva cavallera	FIGURA 64	EXERCICI 15
NOM	DATA	NOTA	

P +

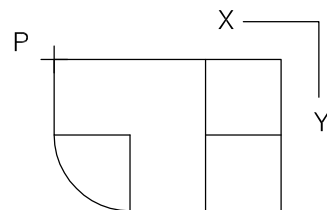
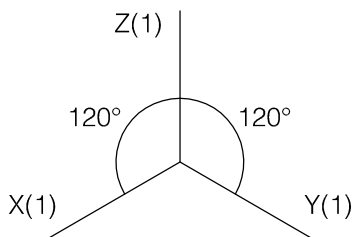
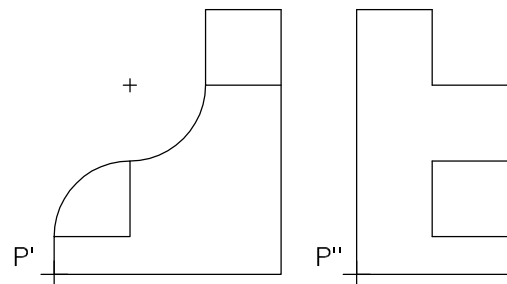

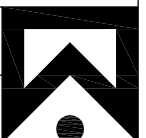
U8	Sistemes axonòmètrics i perspectiva cavallera	FIGURA 65	EXERCICI 16
NOM	DATA	NOTA	

P +

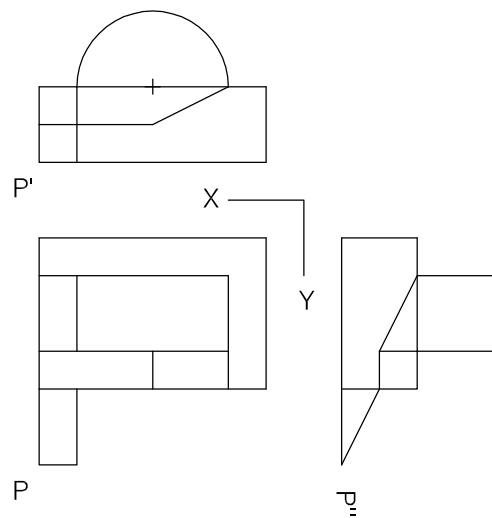
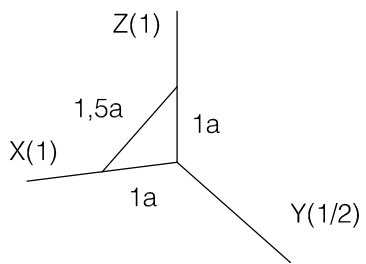

U8

Sistemes axonòmtrics i perspectiva cavallera

FIGURA
66

EXERCICI
17

NOM

DATA

NOTA

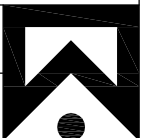

P +

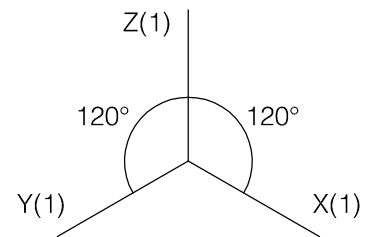
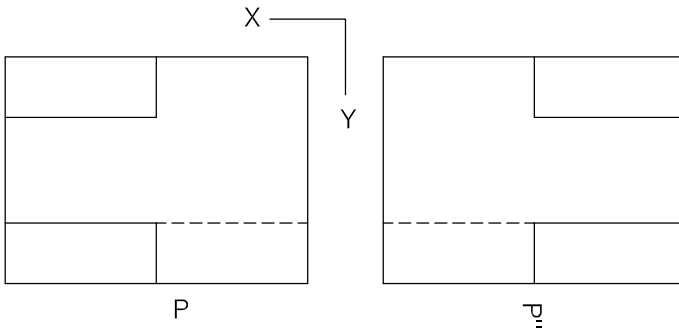
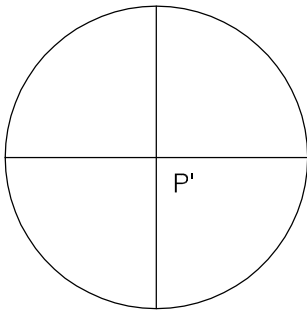

U8	Sistemes axonòmtrics i perspectiva cavallera	FIGURA 67	EXERCICI 18
NOM	DATA	NOTA	

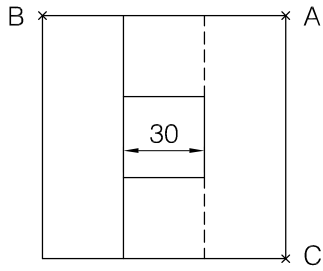
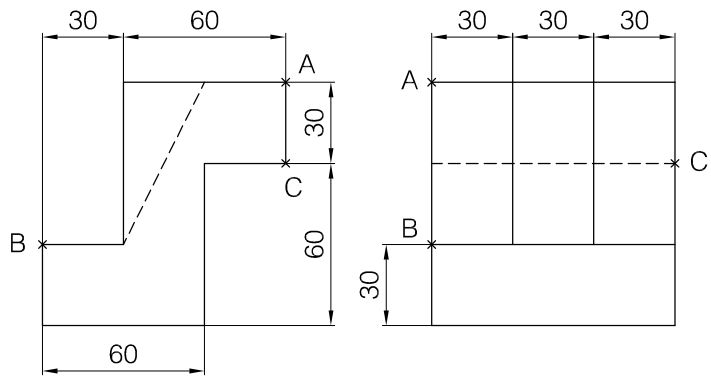

U8	Sistemes axonòmtrics i perspectiva cavallera	FIGURA 68	EXERCICI 19
NOM		DATA	NOTA



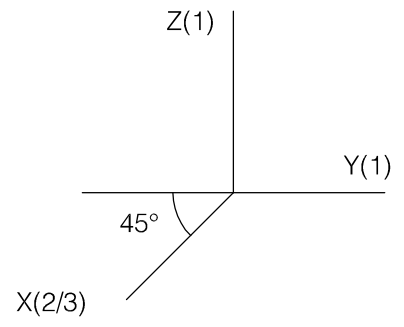
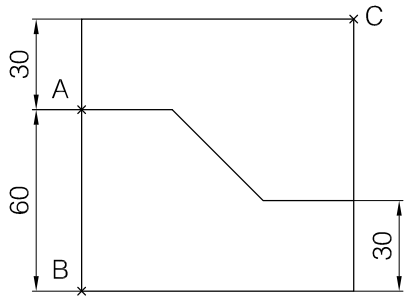
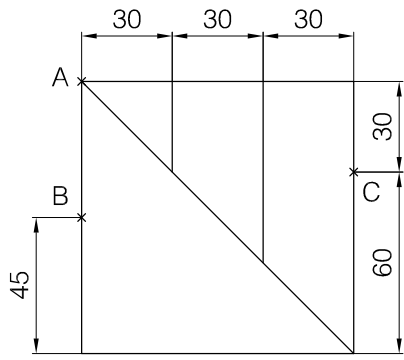

U8	Sistemes axonòmètrics i perspectiva cavallera	FIGURA 69	EXERCICI 20
NOM	DATA	NOTA	

