

U7

El sistema dièdric. Introducció

FIGURA
46

EXERCICI
13

NOM

DATA

NOTA



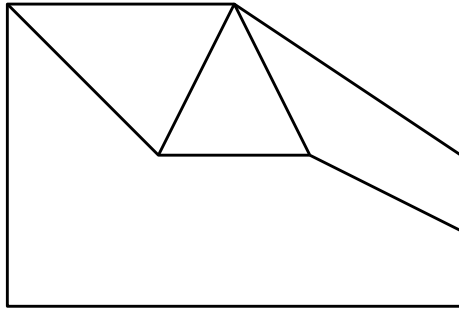

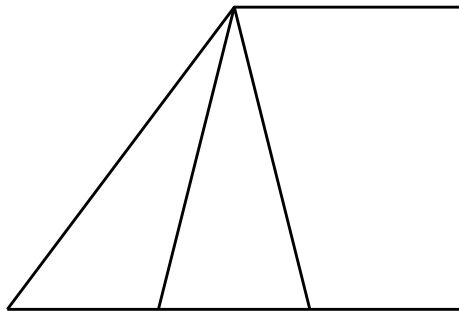

U7

El sistema dièdric. Introducció

FIGURA
47

EXERCICI
14

NOM

DATA

NOTA

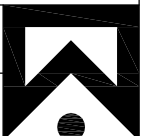

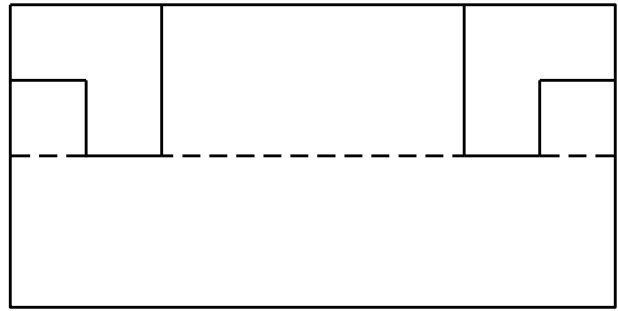
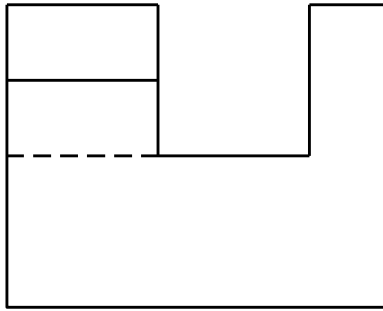

U7

El sistema dièdric. Introducció

FIGURA
48

EXERCICI
15

NOM

DATA

NOTA

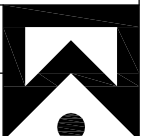

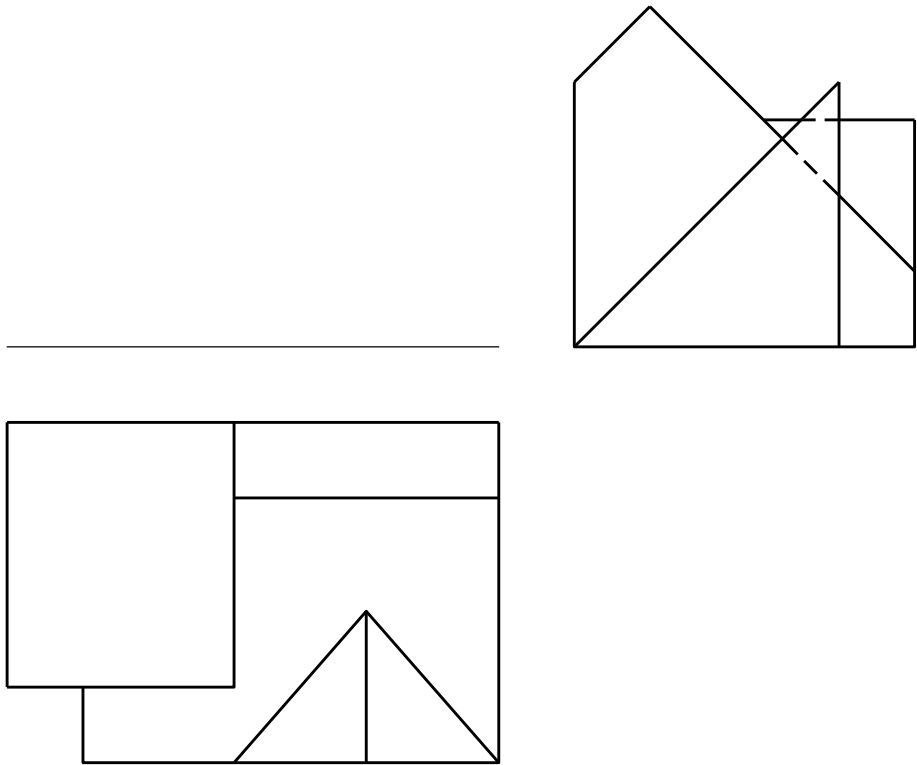

U7	El sistema dièdric. Introducció	FIGURA 49	EXERCICI 16
NOM	DATA		NOTA



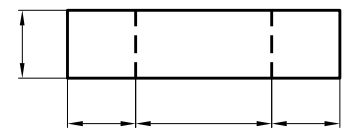
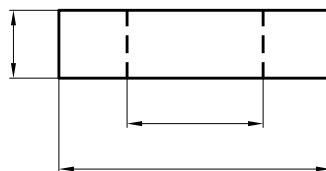
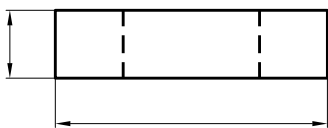
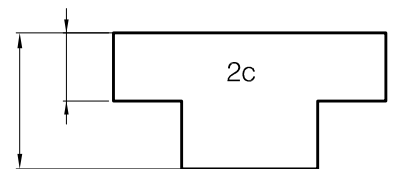
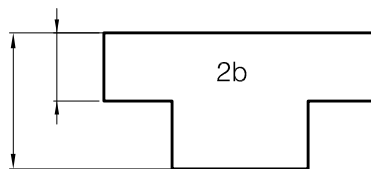
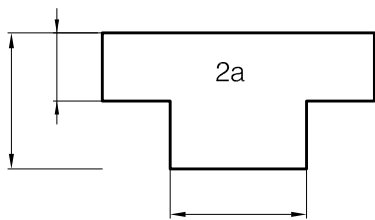
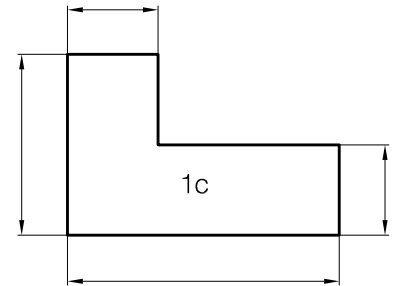
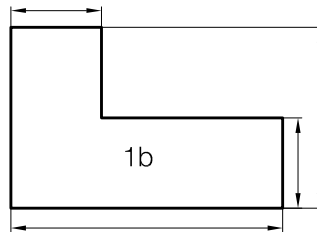
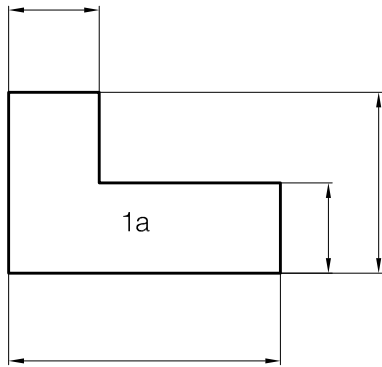

U7

El sistema dièdric. Introducció

FIGURA
50

EXERCICI
17

NOM

DATA

NOTA



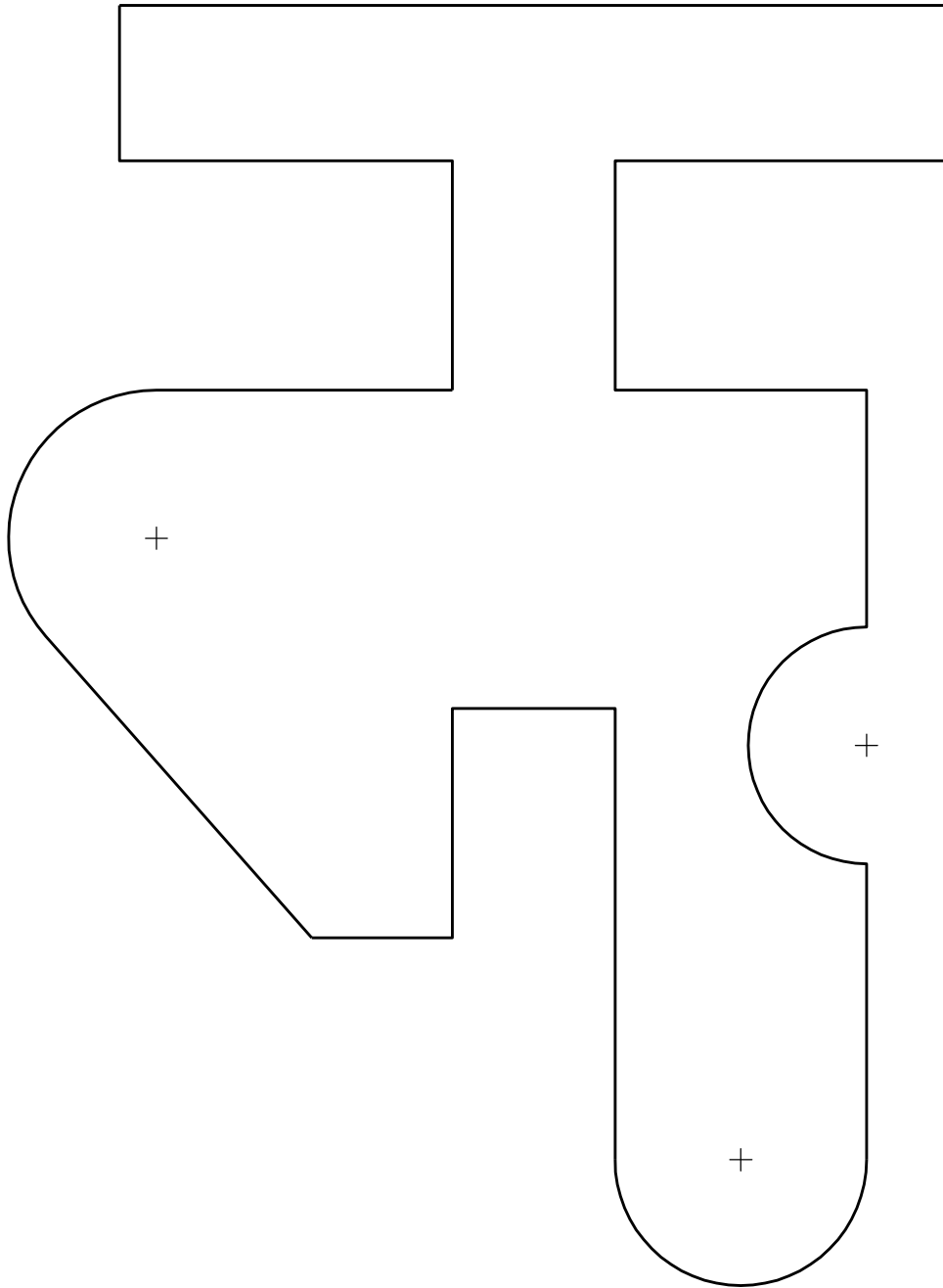

U7	El sistema dièdric. Introducció	FIGURA 51	EXERCICI 18
NOM	DATA	NOTA	

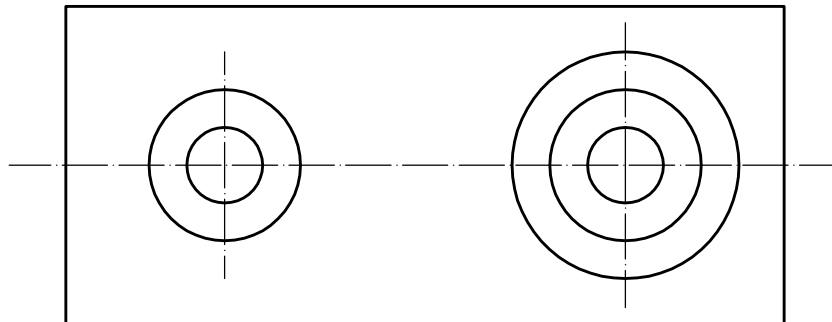
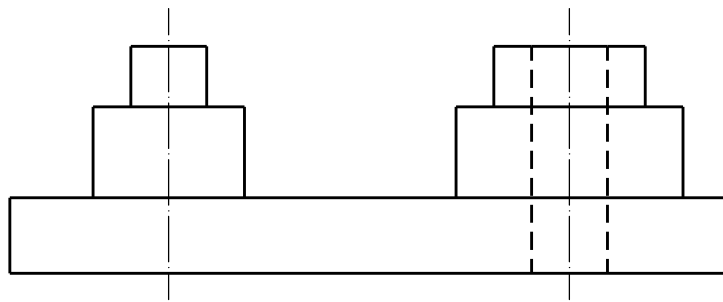

U7

El sistema dièdric. Introducció

FIGURA
52

EXERCICI
19

NOM

DATA

NOTA

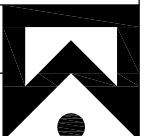

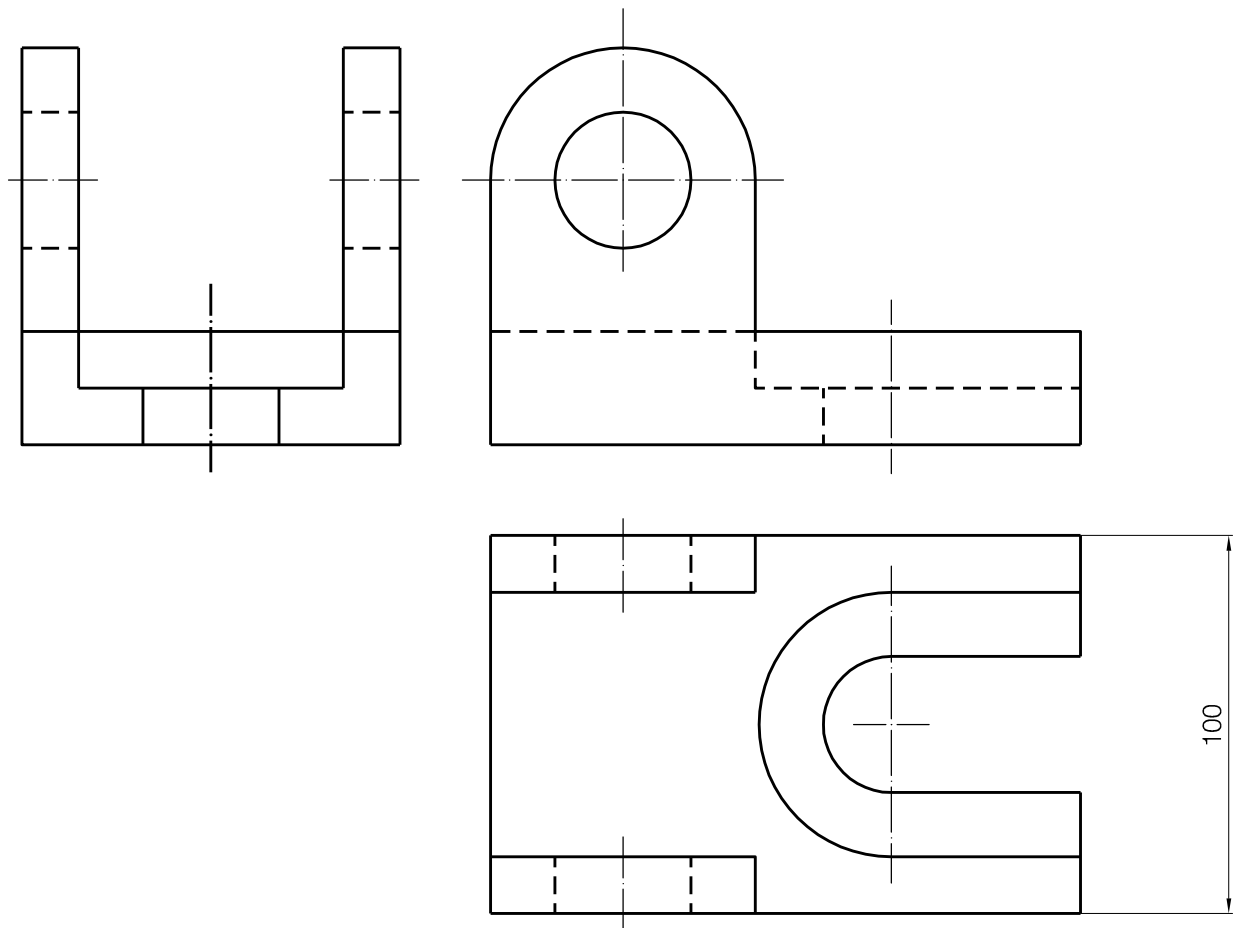

U7	El sistema dièdric. Introducció	FIGURA 53	EXERCICI 20
NOM	DATA		NOTA



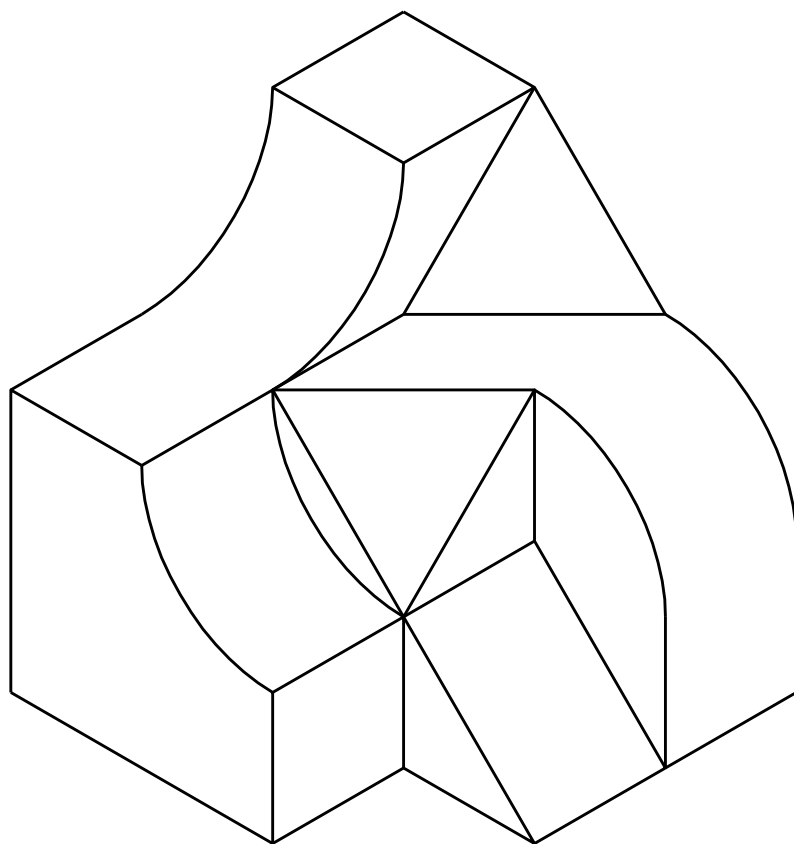

U7

El sistema dièdric. Introducció

FIGURA
54

EXERCICI
21

NOM

DATA

NOTA

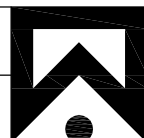

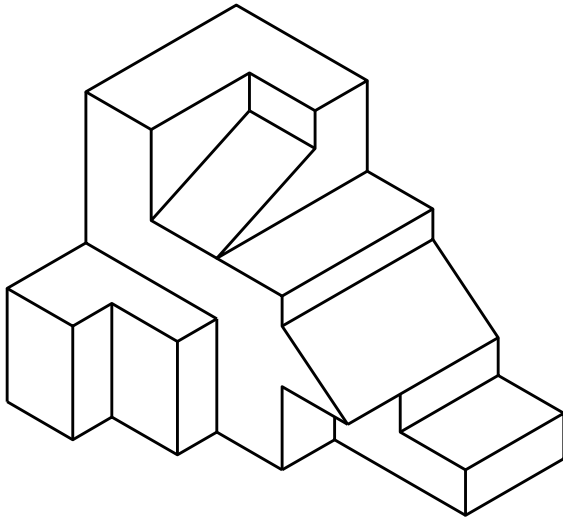

U7	El sistema dièdric. Introducció	FIGURA 55	EXERCICI 22
NOM	DATA		NOTA



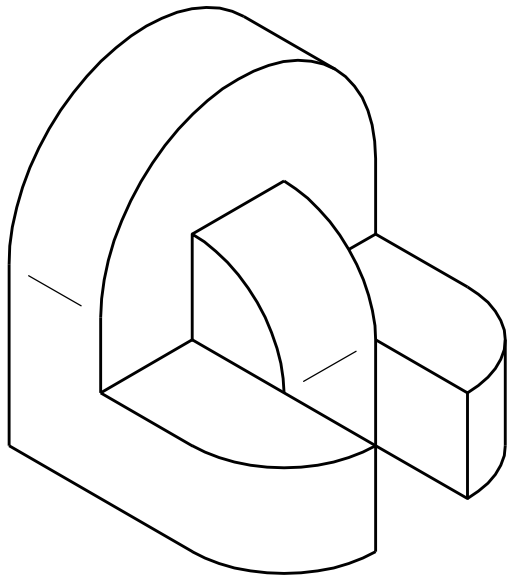

U7

El sistema dièdric. Introducció

FIGURA
56

EXERCICI
23

NOM

DATA

NOTA

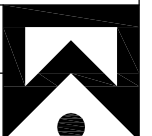

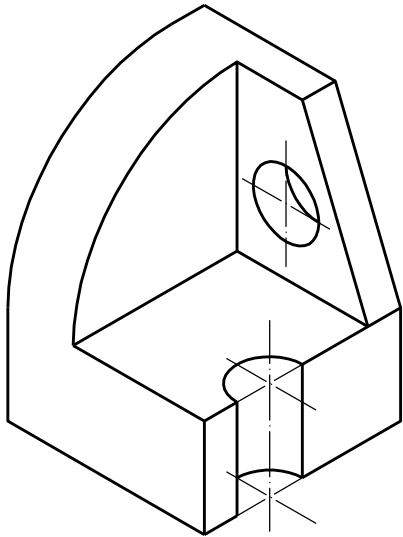

U7

El sistema dièdric. Introducció

FIGURA
57

EXERCICI
24

NOM

DATA

NOTA

