

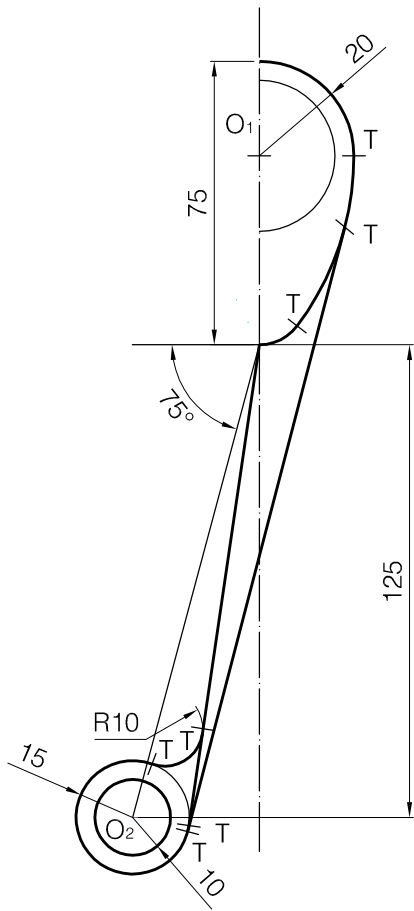

+  
O

U5	Corbes geomètriques	FIGURA 48	EXERCICI 23
NOM	DATA	NOTA	



U5	Corbes geomètriques	FIGURA 49	EXERCICI 24
NOM	DATA	NOTA	

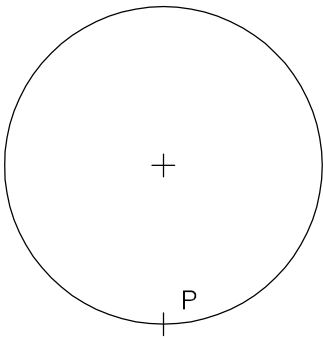

U5	Corbes geomètriques	FIGURA 50	EXERCICI 26	
NOM	DATA		NOTA	

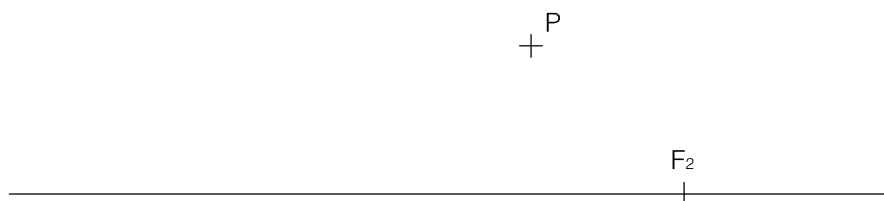

U5	Corbes geomètriques	FIGURA 51	EXERCICI 27	
NOM		DATA	NOTA	

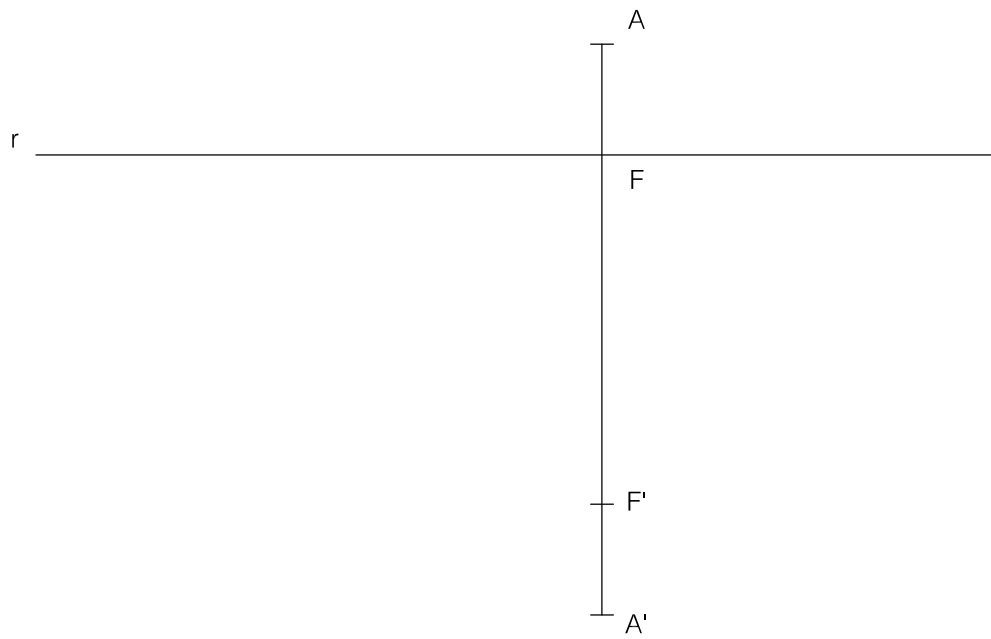

U5	Corbes geomètriques	FIGURA 52	EXERCICI 28
NOM	DATA		NOTA



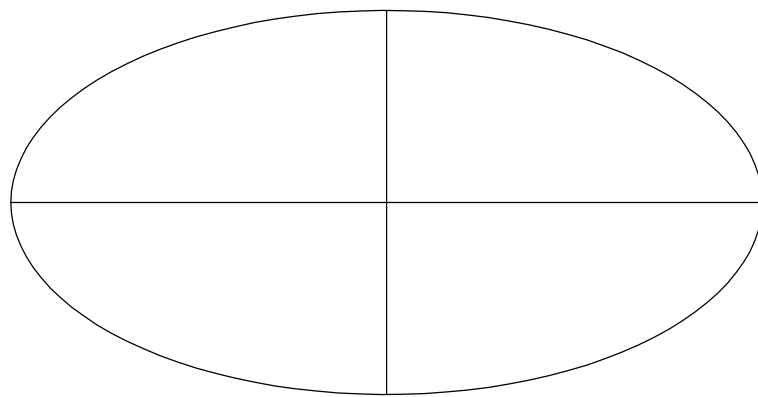

+ P

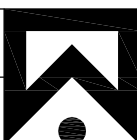
U5	Corbes geomètriques	FIGURA 53	EXERCICI 29
NOM	DATA	NOTA	

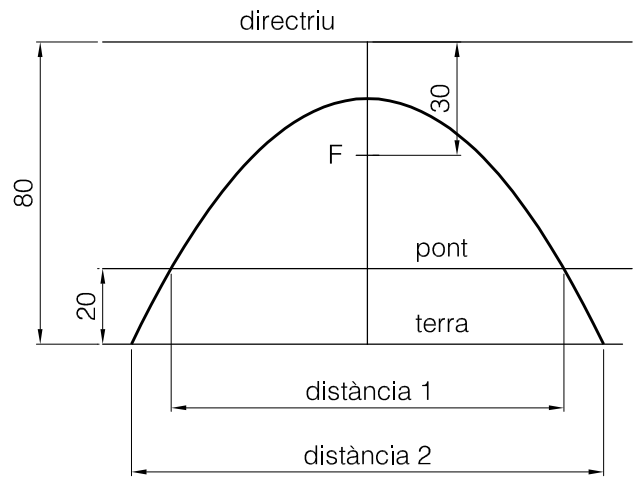

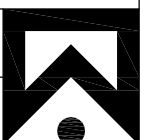
U5	Corbes geomètriques	FIGURA 54	EXERCICI 30
NOM	DATA	NOTA	

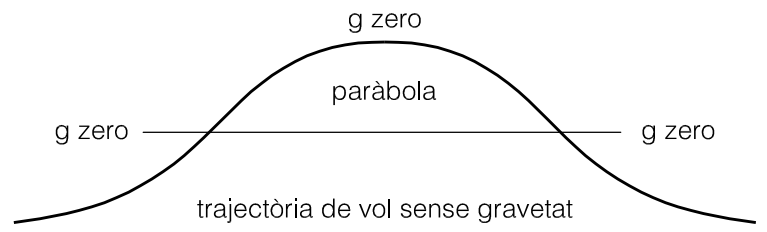

+<sup>v</sup>

R<sup>+</sup>

+<sub>s</sub>

U5

Corbes geomètriques

FIGURA  
55

EXERCICI  
31

NOM

DATA

NOTA

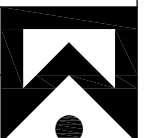



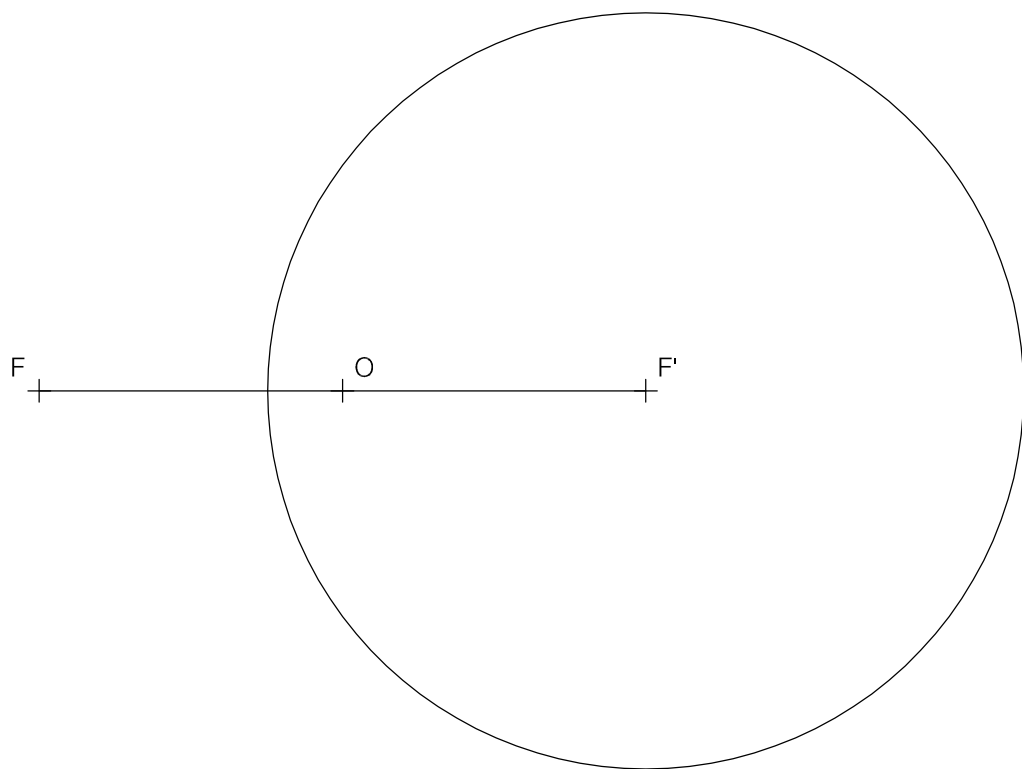

U5	Corbes geomètriques	FIGURA 56	EXERCICI 32
NOM	DATA		NOTA

