

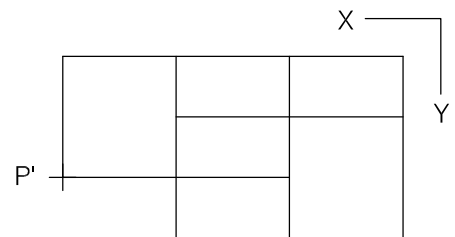

P +

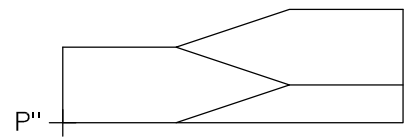
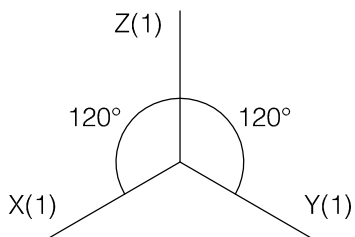
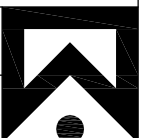
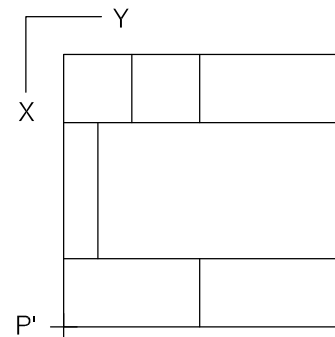
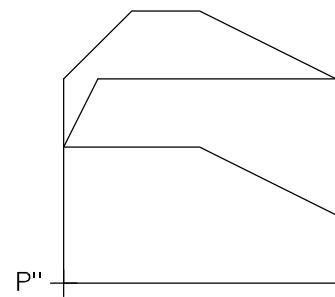
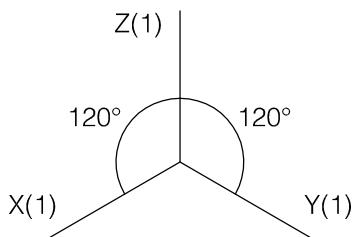

U8	Sistemes axonòmtrics i perspectiva cavallera	FIGURA 38	EXERCICI 1
NOM	DATA	NOTA	

P +



U8	Sistemes axonòmrics i perspectiva cavallera	FIGURA 39	EXERCICI 1
NOM	DATA	NOTA	

+ P

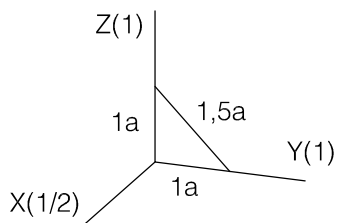
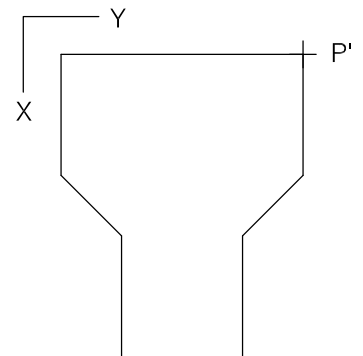
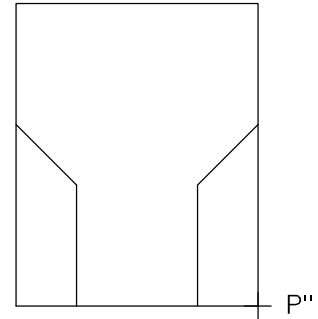

U8

Sistemes axonòmtrics i perspectiva cavallera

FIGURA
40

EXERCICI
1

NOM

DATA

NOTA

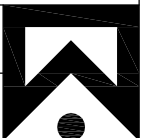

P +

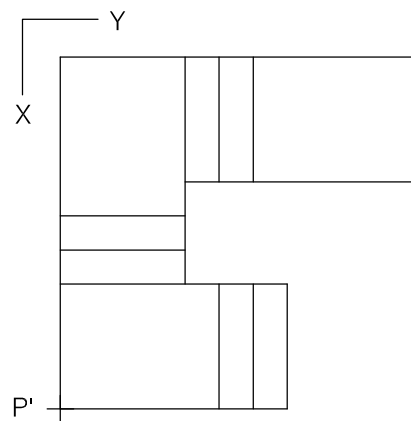
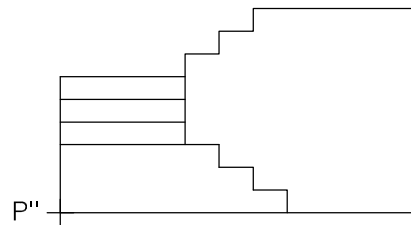
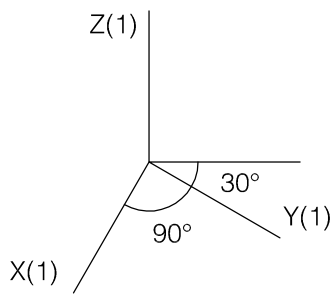

U8	Sistemes axonòmtrics i perspectiva cavallera	FIGURA 41	EXERCICI 1
NOM	DATA		NOTA



+ P

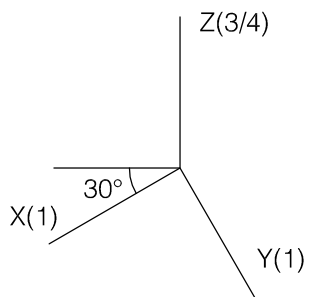
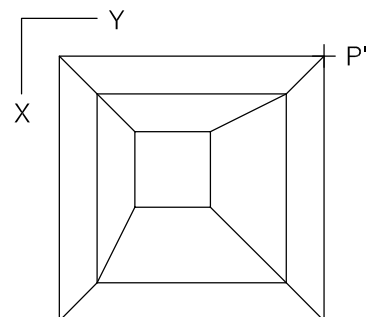
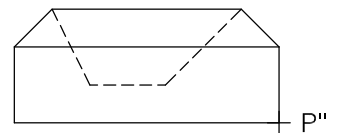

U8

Sistemes axonòmtrics i perspectiva cavallera

FIGURA
42

EXERCICI
1

NOM

DATA

NOTA

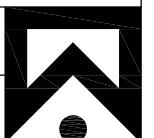

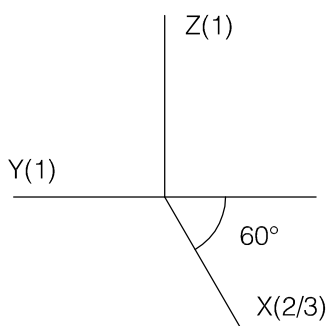

+ P

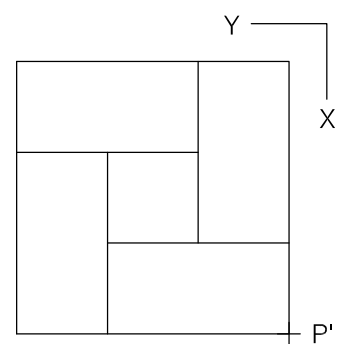
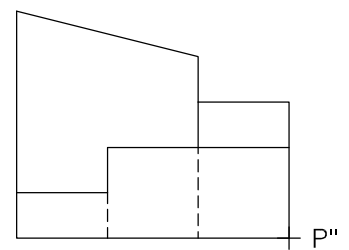

U8	Sistemes axonòmtrics i perspectiva cavallera	FIGURA 43	EXERCICI 1
NOM	DATA	NOTA	

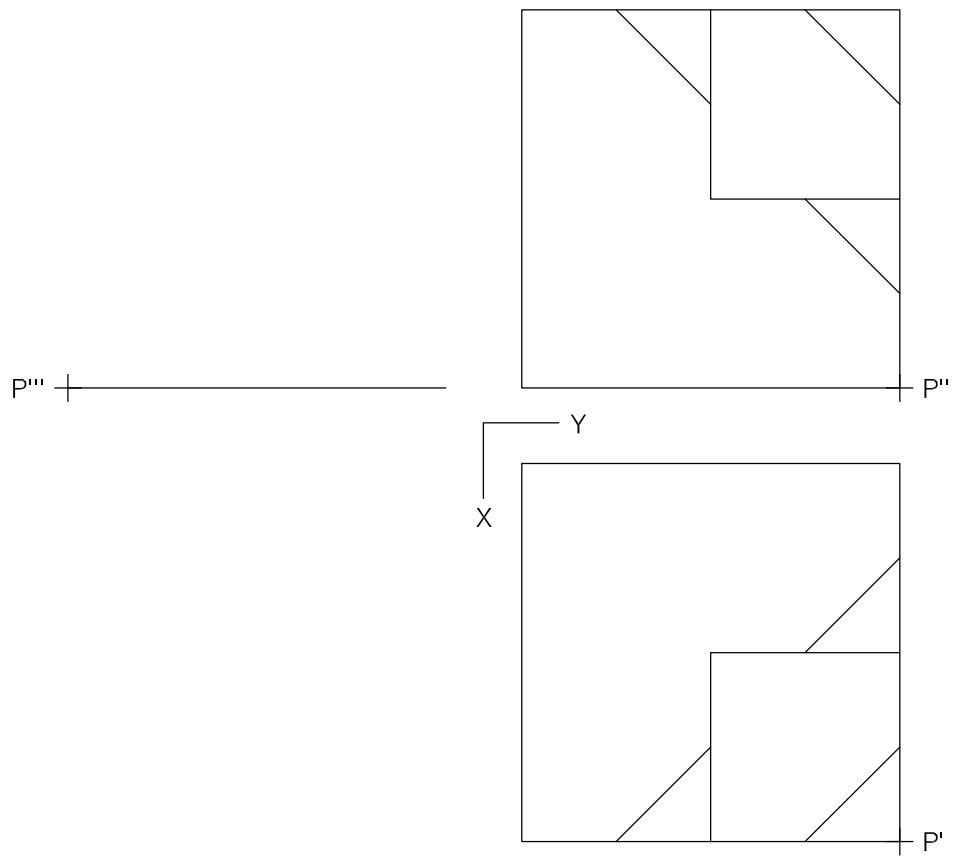

P +

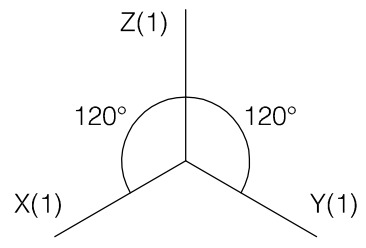

U8	Sistemes axonòmrics i perspectiva cavallera	FIGURA 44	EXERCICI 2
NOM	DATA	NOTA	

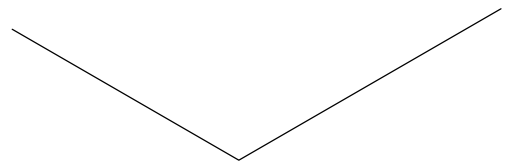
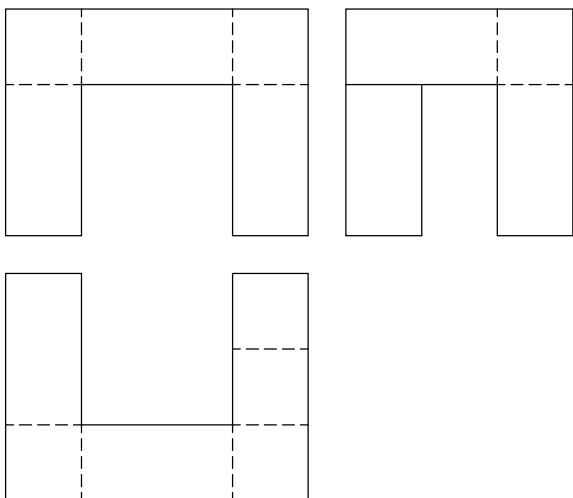
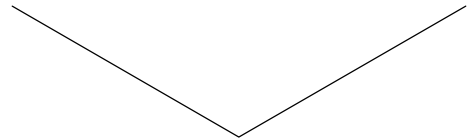
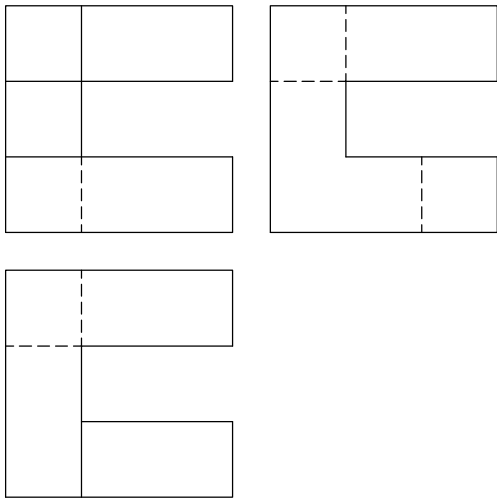
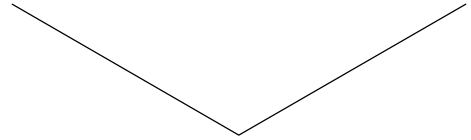
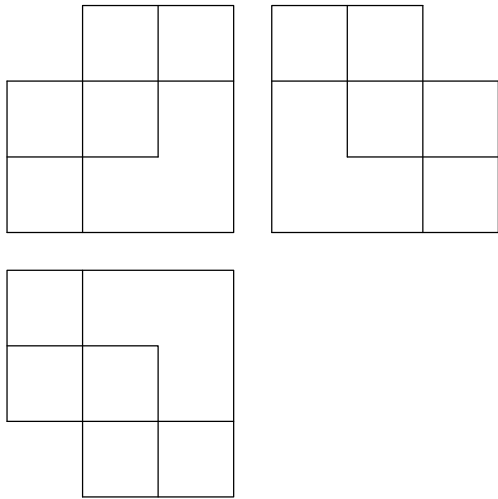

U8	Sistemes axonòmrics i perspectiva cavallera	FIGURA 45	EXERCICI 3
NOM	DATA		NOTA



P
+

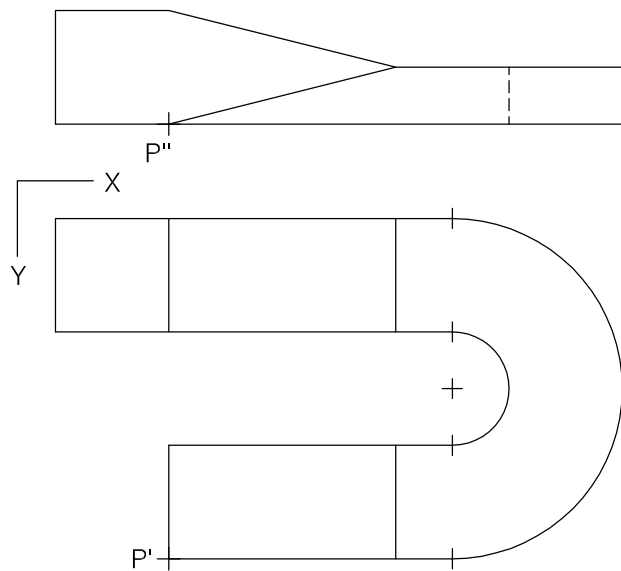
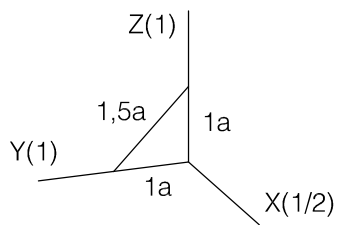

U8	Sistemes axonòmtrics i perspectiva cavallera	FIGURA 46	EXERCICI 4
NOM	DATA		NOTA

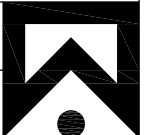

P +

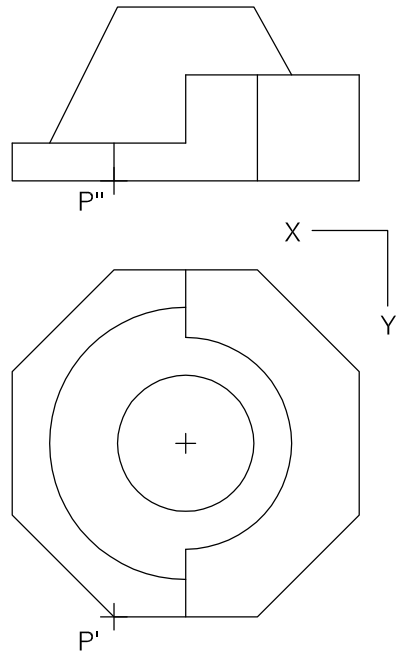
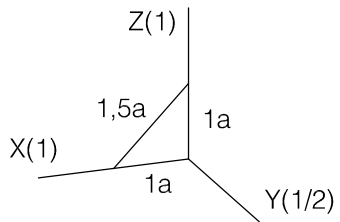

U8	Sistemes axonòmètrics i perspectiva cavallera	FIGURA 47	EXERCICI 4
NOM	DATA		NOTA

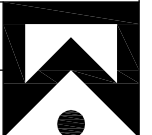

P
+

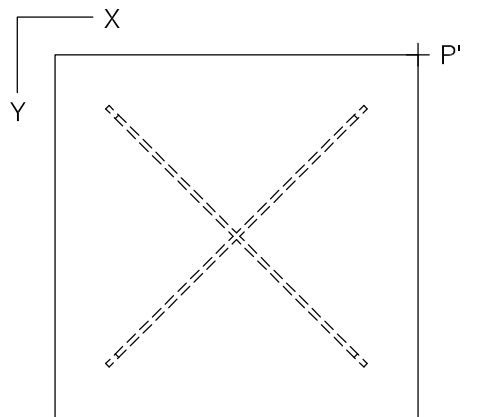
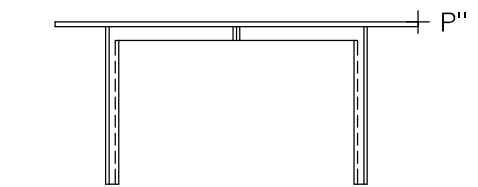
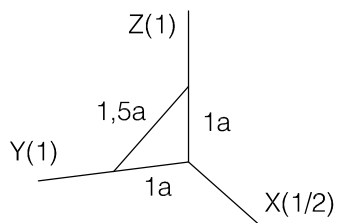

LA SUPERFÍCIE DE LA TAULA ÉS TRANSPARENT

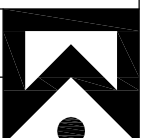
U8	Sistemes axonòmètrics i perspectiva cavallera	FIGURA 48	EXERCICI 5
NOM	DATA	NOTA	

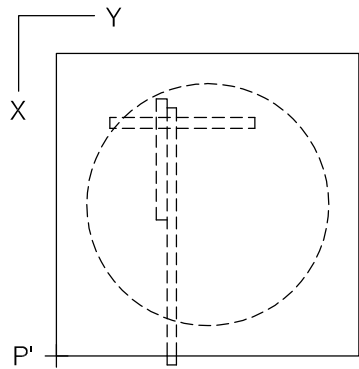
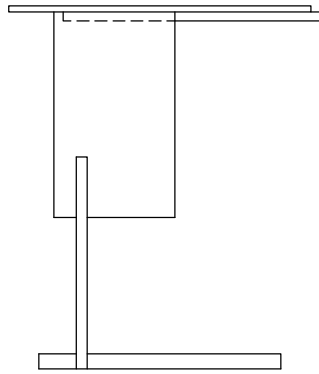
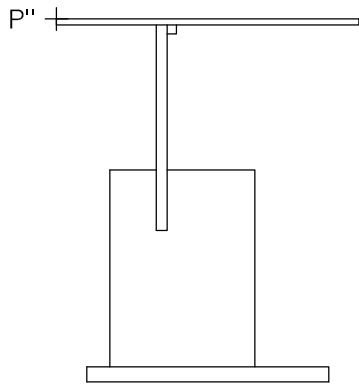

P +

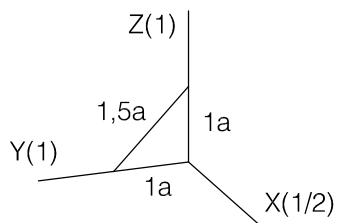

U8	Sistemes axonòmrics i perspectiva cavallera	FIGURA 49	EXERCICI 5
NOM	DATA	NOTA	



+
P

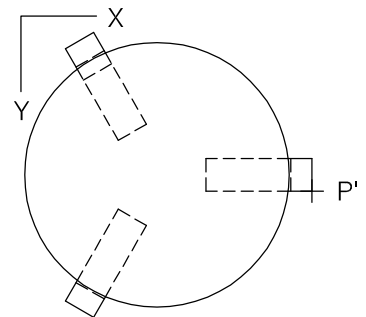
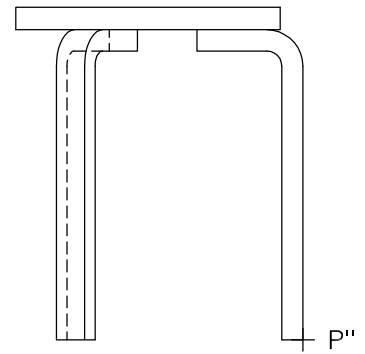
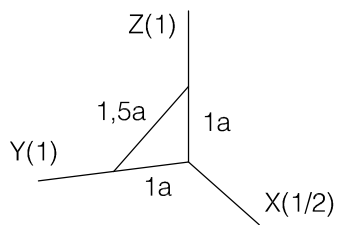

U8

Sistemes axonòmtrics i perspectiva cavallera

FIGURA
50

EXERCICI
5

NOM

DATA

NOTA

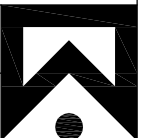

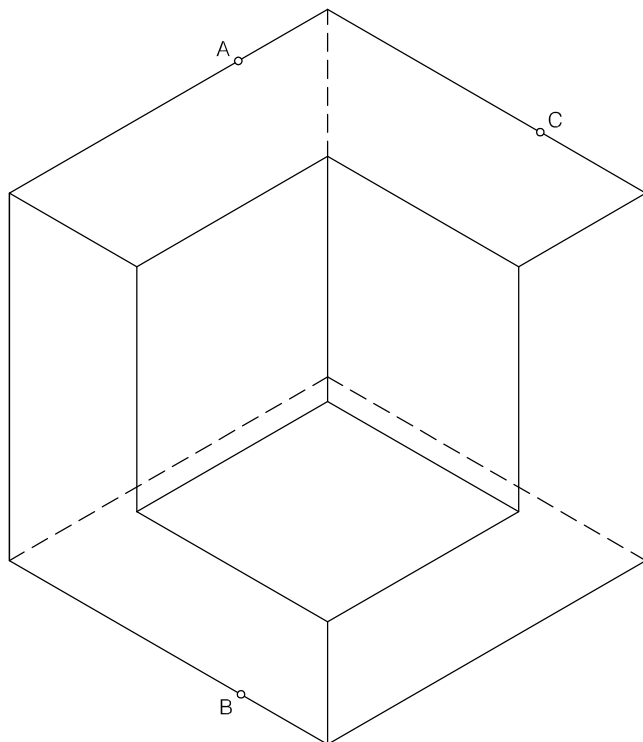
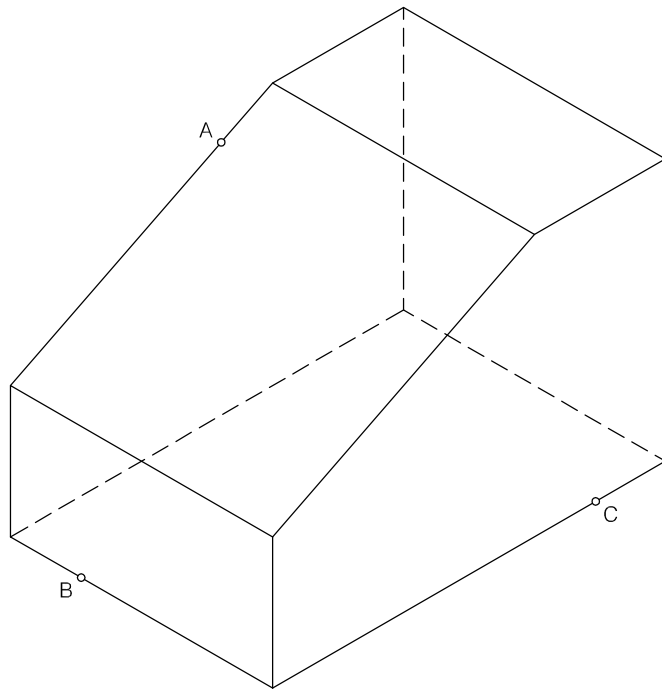

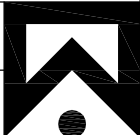
U8	Sistemes axonòmtrics i perspectiva cavallera	FIGURA 51	EXERCICI 6
NOM	DATA	NOTA	

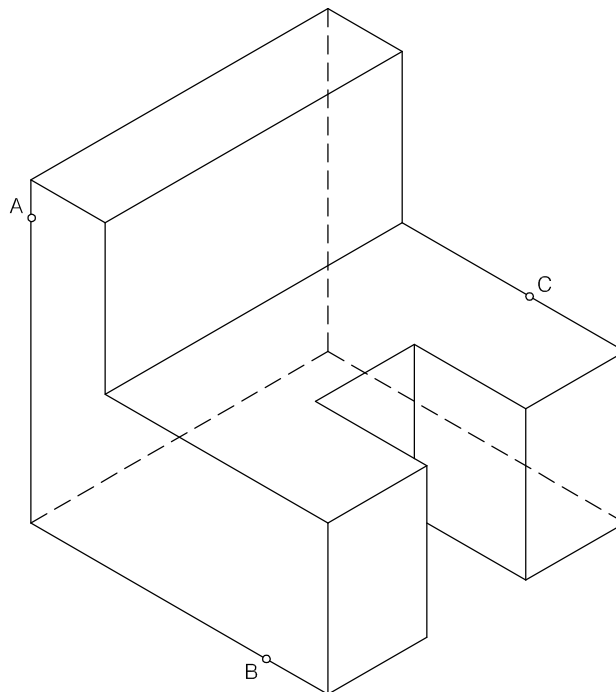
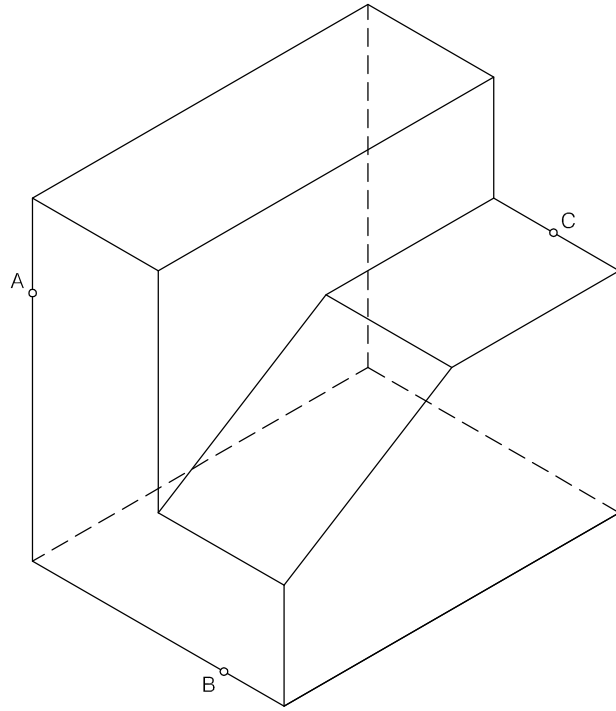

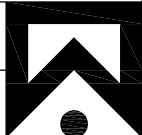
U8	Sistemes axonòmtrics i perspectiva cavallera	FIGURA 52	EXERCICI 6
NOM	DATA	NOTA	

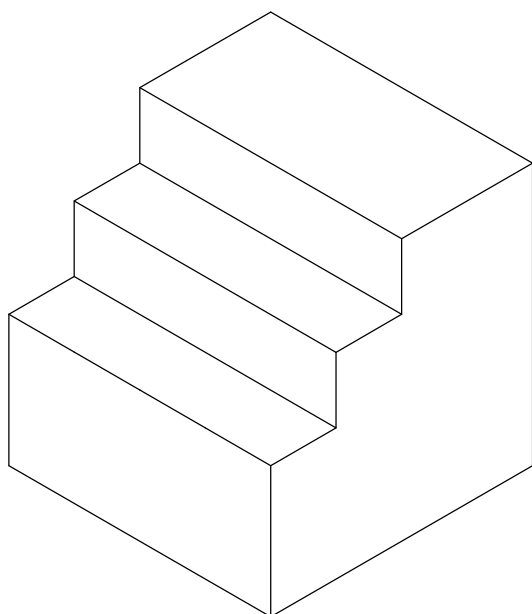
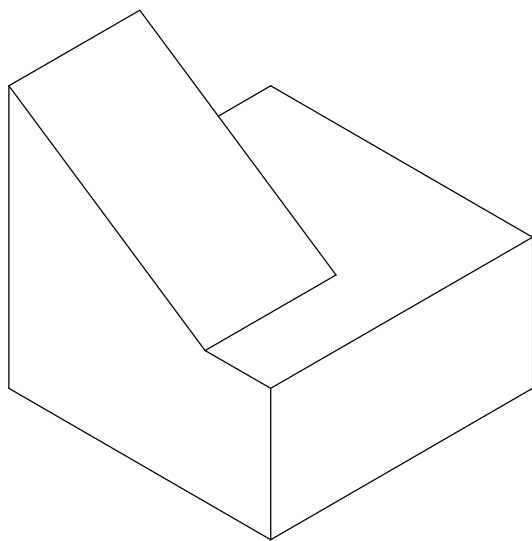

U8

Sistemes axonòmètrics i perspectiva cavallera

FIGURA
53

EXERCICI
7

NOM

DATA

NOTA

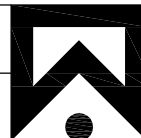

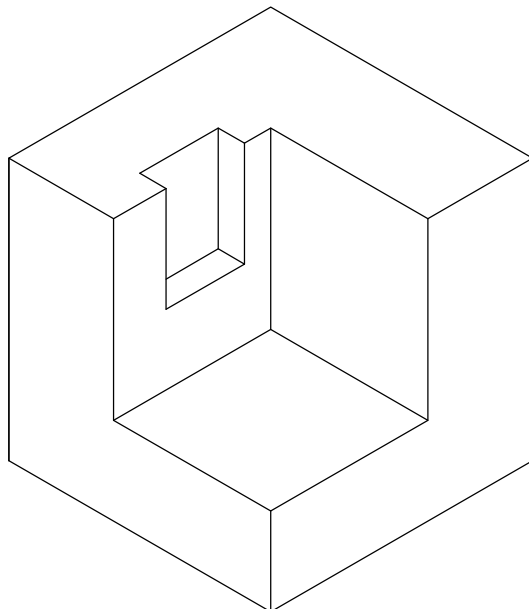
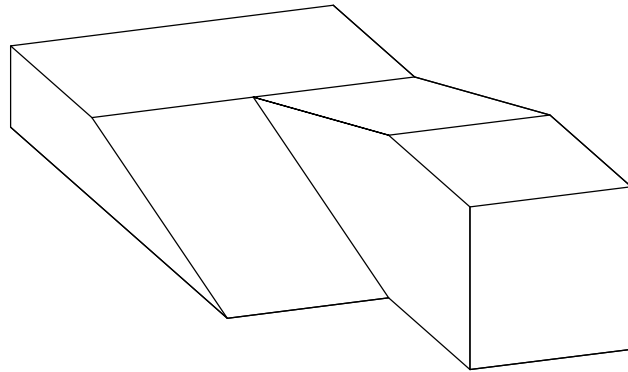

U8

Sistemes axonòmètrics i perspectiva cavallera

FIGURA
54

EXERCICI
7

NOM

DATA

NOTA



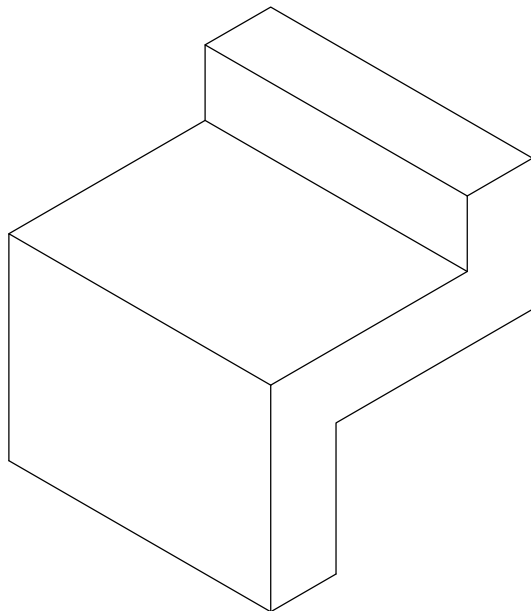
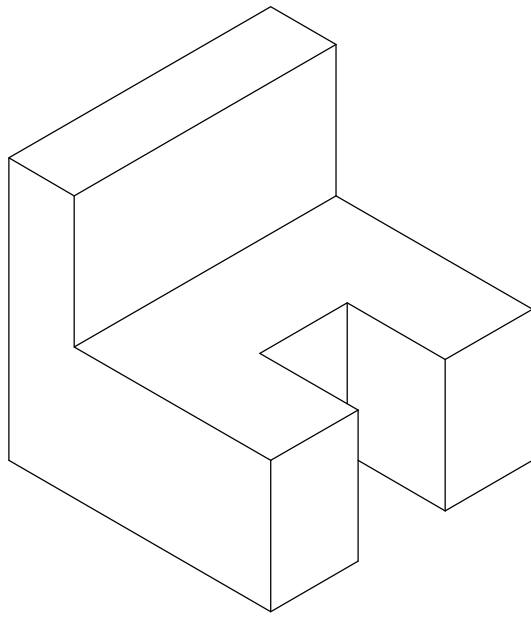

U8

Sistemes axonòmtrics i perspectiva cavallera

FIGURA
55

EXERCICI
7

NOM

DATA

NOTA

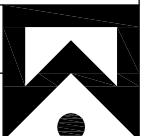

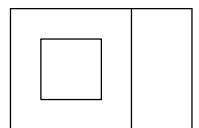
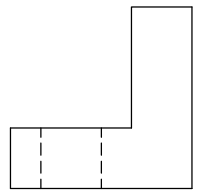
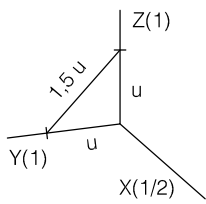
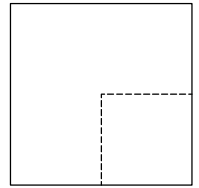
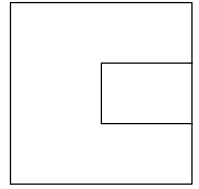
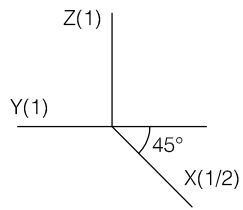

U8	Sistemes axonòmètrics i perspectiva cavallera	FIGURA 56	EXERCICI 8
NOM	DATA	NOTA	

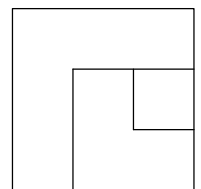
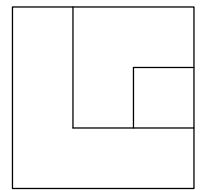
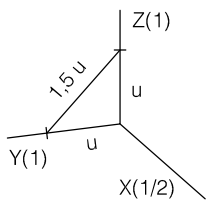
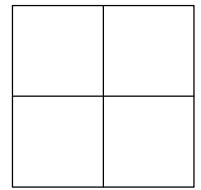
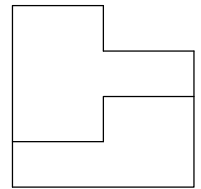
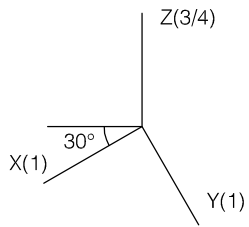

U8	Sistemes axonòmètrics i perspectiva cavallera	FIGURA 57	EXERCICI 8
NOM	DATA		NOTA

