

U7	El sistema dièdric. Introducció	FIGURA 25	EXERCICI 1
NOM	DATA	NOTA	

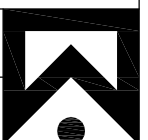

U7	El sistema dièdric. Introducció	FIGURA 26	EXERCICI 2
NOM	DATA	NOTA	

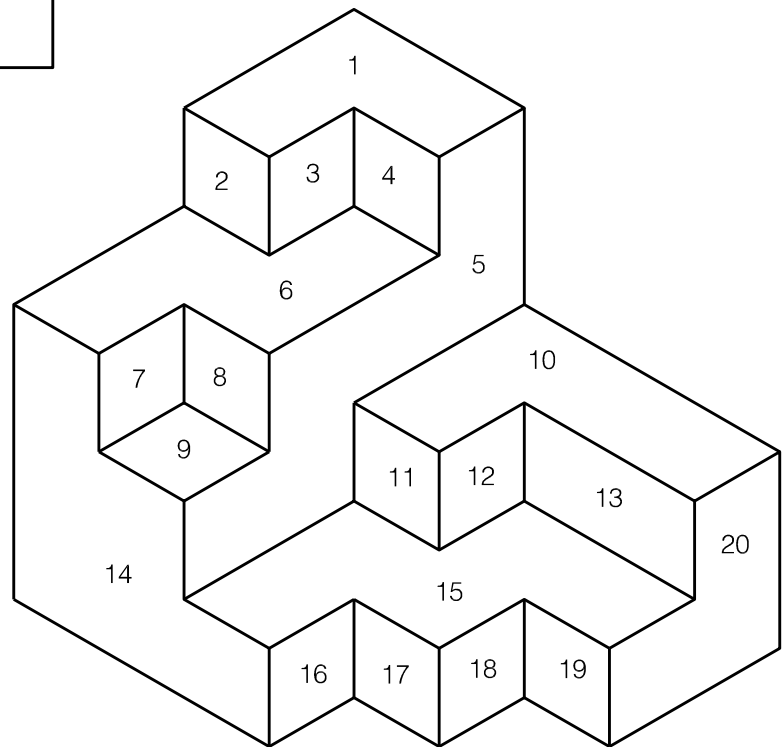
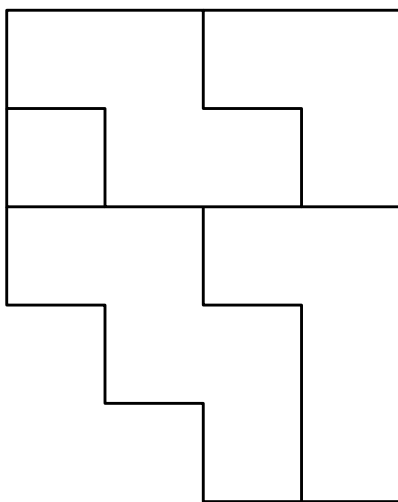
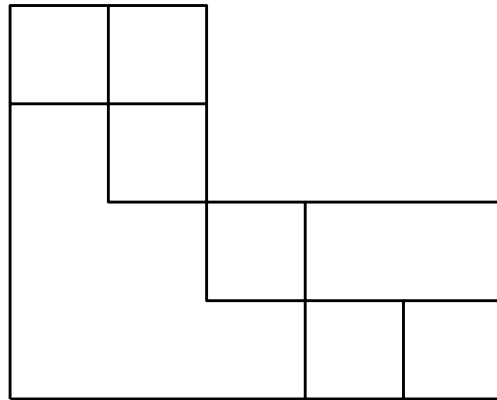
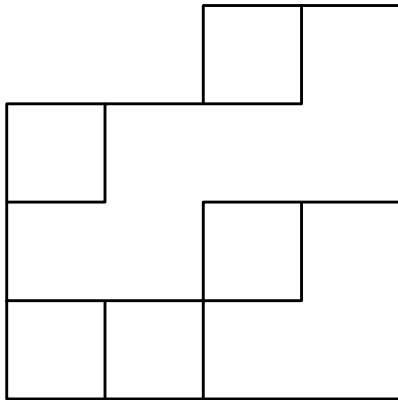
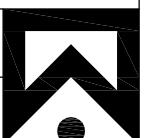
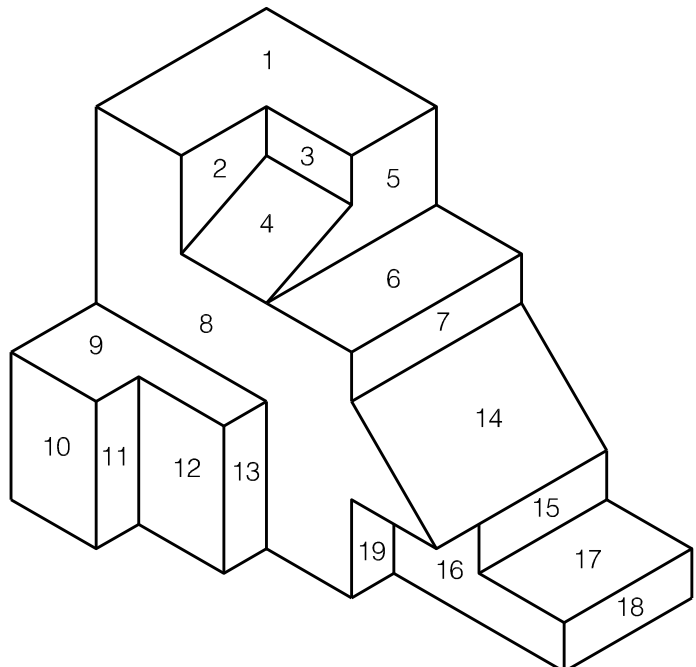
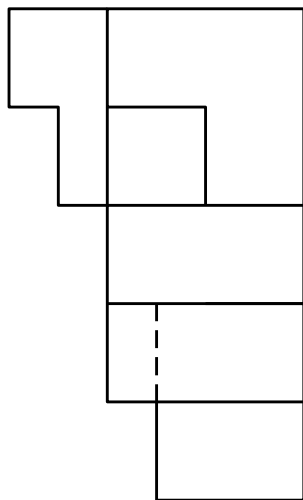
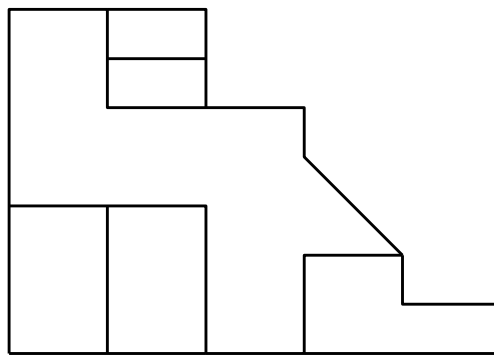
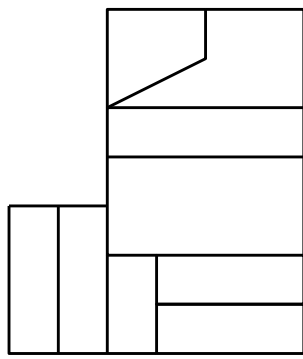
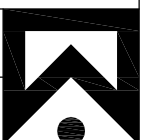

U7	El sistema dièdric. Introducció	FIGURA 27	EXERCICI 2
NOM	DATA	NOTA	

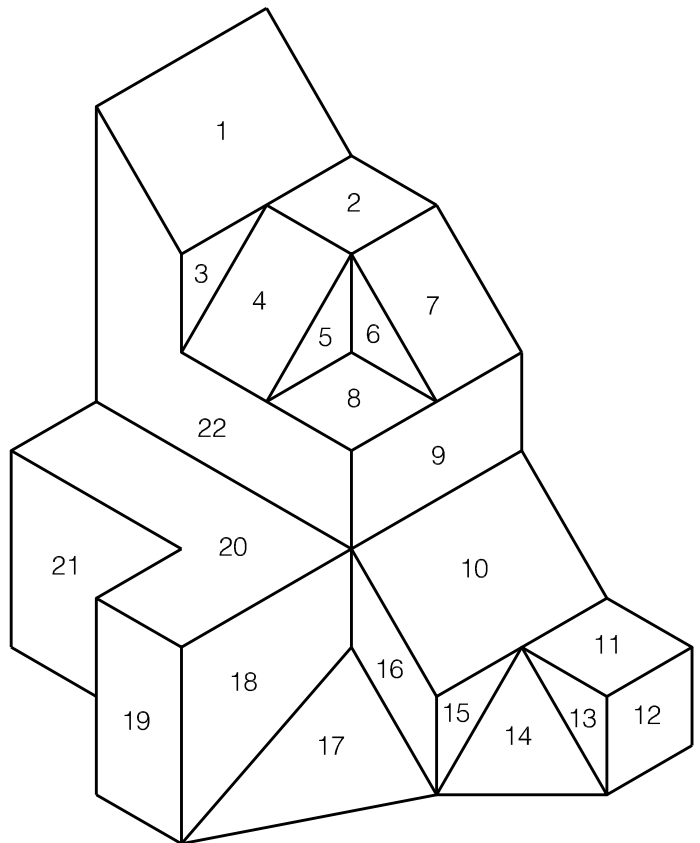
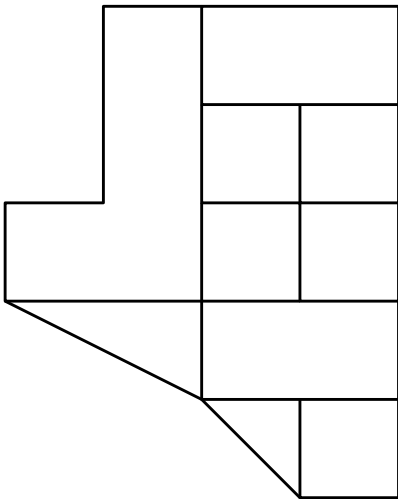
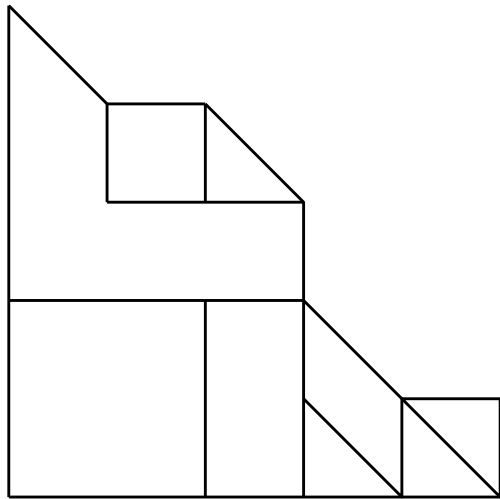
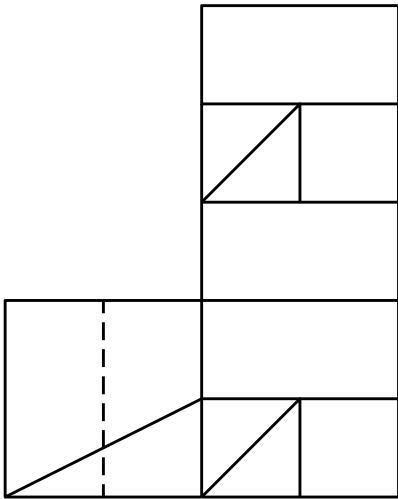

U7	El sistema dièdric. Introducció	FIGURA 28	EXERCICI 2
NOM	DATA	NOTA	

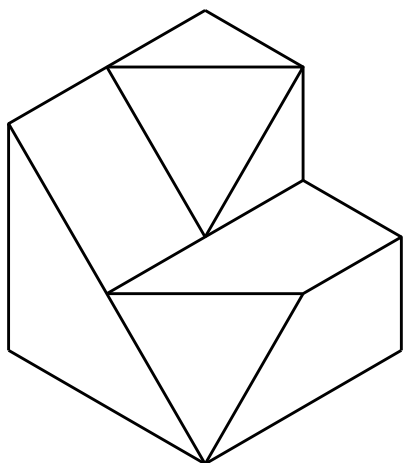
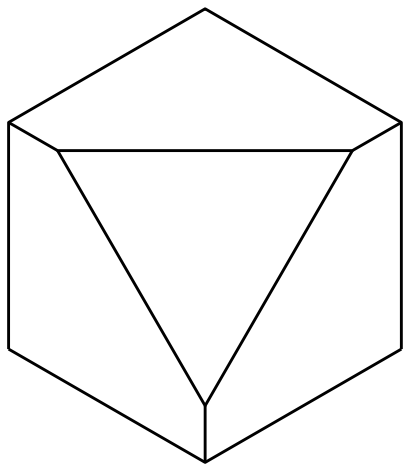

U7

El sistema dièdric. Introducció

FIGURA
29

EXERCICI
3

NOM

DATA

NOTA

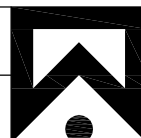

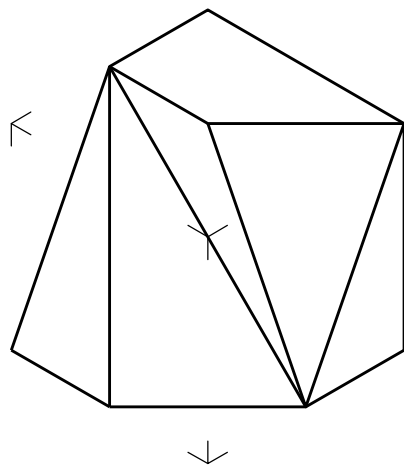
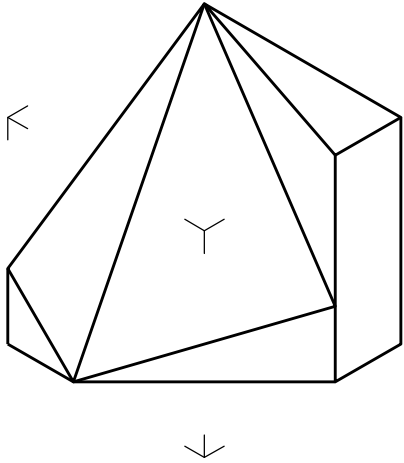

U7

El sistema dièdric. Introducció

FIGURA
30

EXERCICI
3

NOM

DATA

NOTA

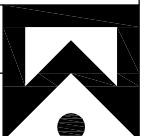

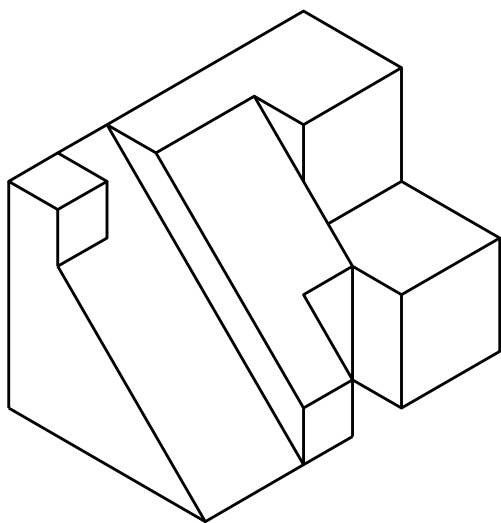
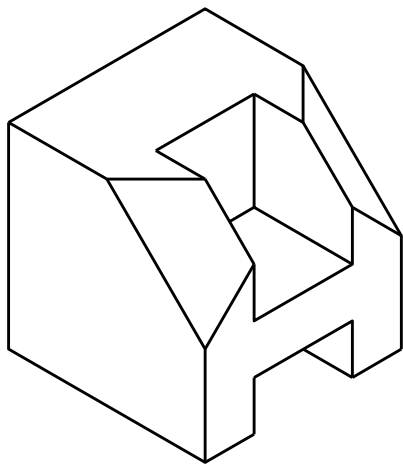

U7

El sistema dièdric. Introducció

FIGURA

31

EXERCICI

3

NOM

DATA

NOTA

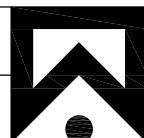

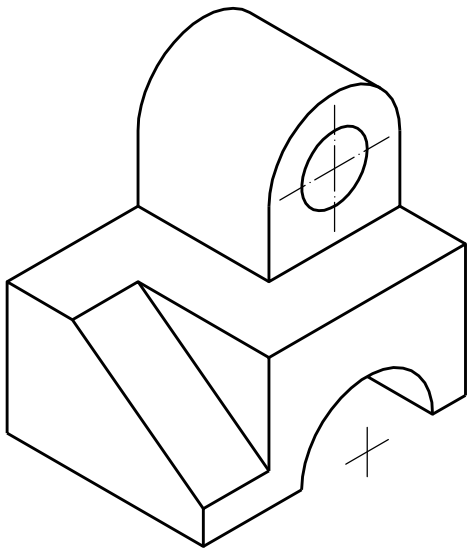
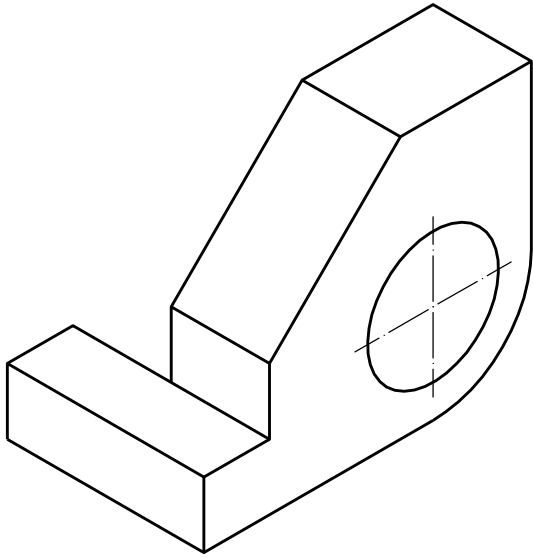

U7

El sistema dièdric. Introducció

FIGURA
32

EXERCICI
4

NOM

DATA

NOTA

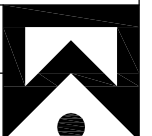

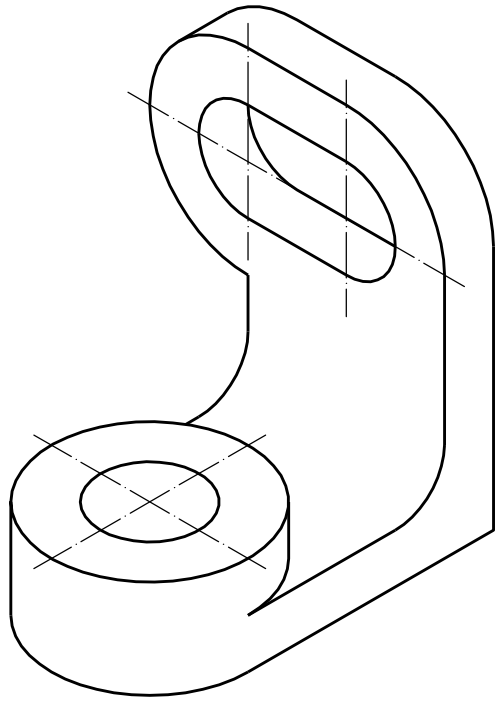

U7

El sistema dièdric. Introducció

FIGURA
33

EXERCICI
4

NOM

DATA

NOTA

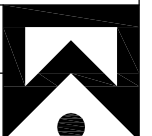

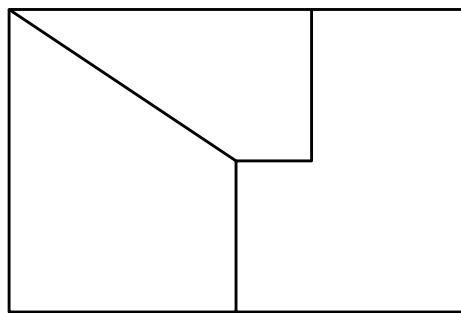

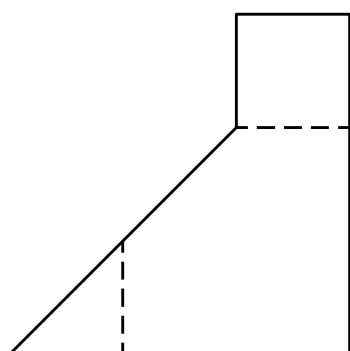
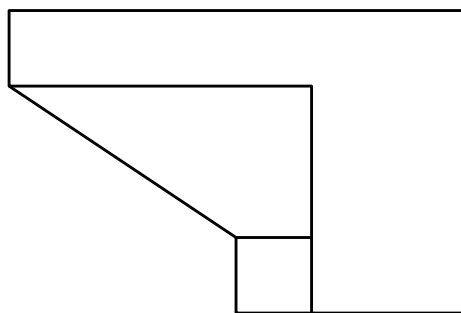

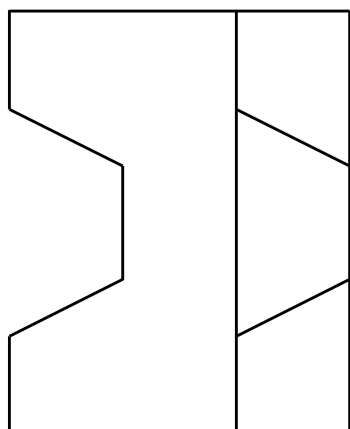

U7

El sistema dièdric. Introducció

FIGURA
34

EXERCICI
5

NOM

DATA

NOTA

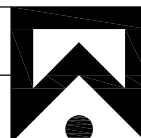

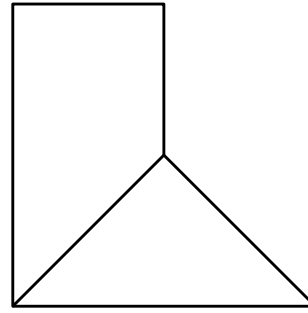
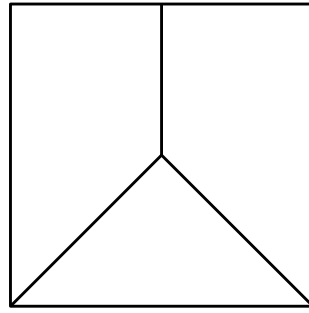

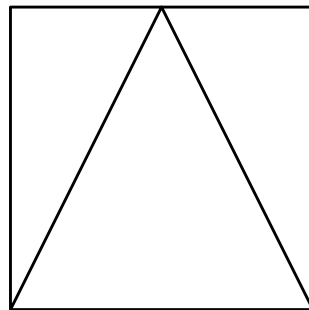

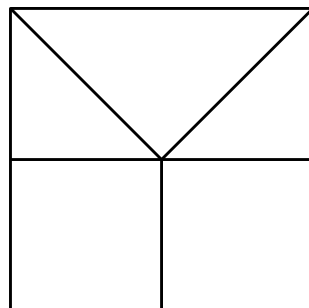

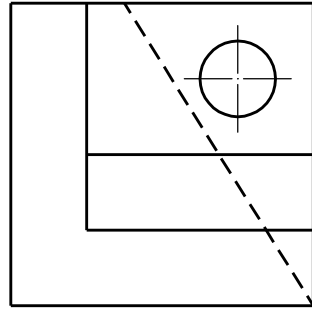
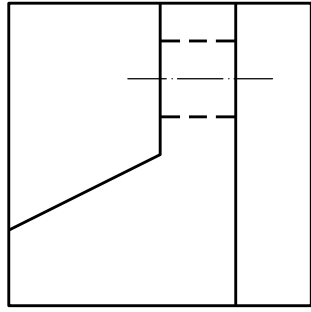

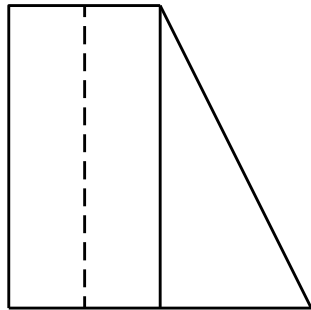

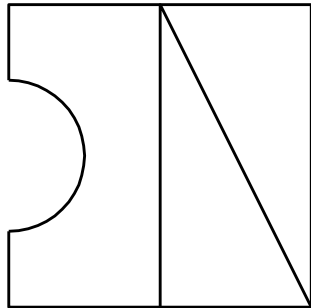



U7	El sistema dièdric. Introducció	FIGURA 36	EXERCICI 5
NOM	DATA	NOTA	

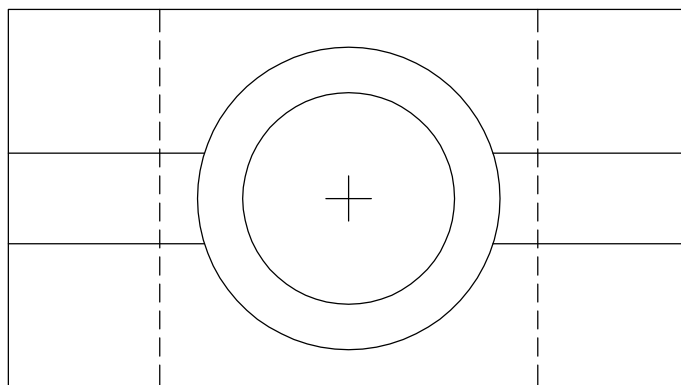
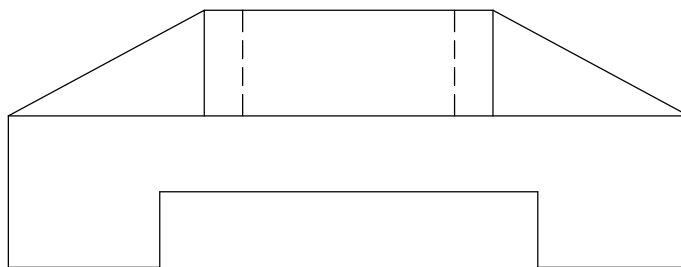
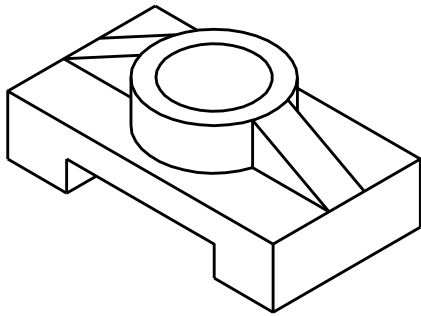

U7

El sistema dièdric. Introducció

FIGURA
37

EXERCICI
6

NOM

DATA

NOTA



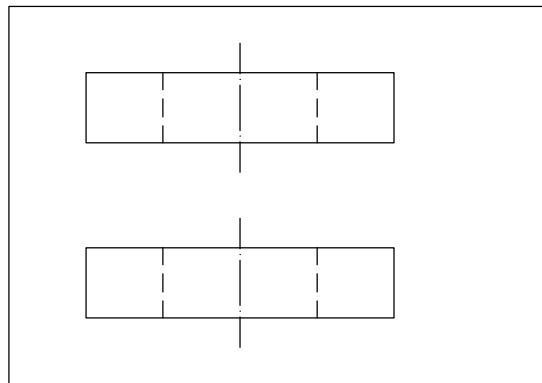
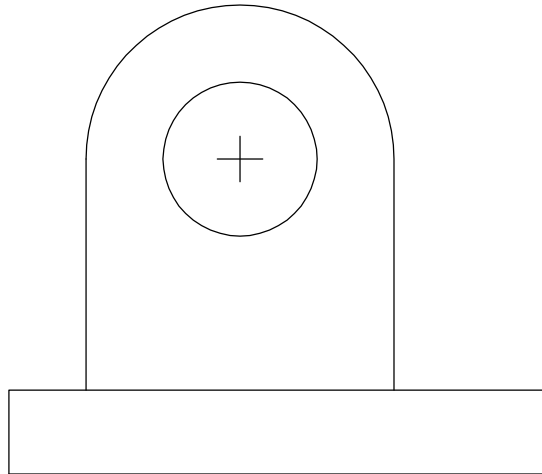
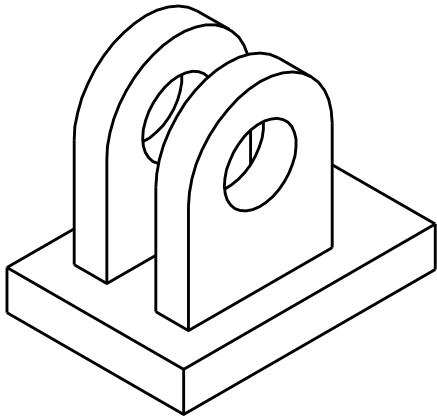

U7

El sistema dièdric. Introducció

FIGURA
38

EXERCICI
6

NOM

DATA

NOTA

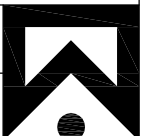

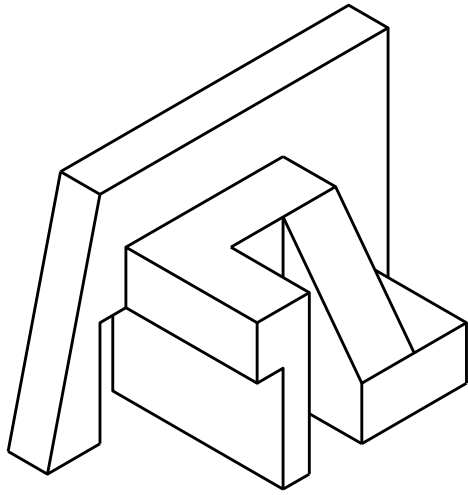

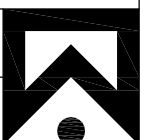
U7	El sistema dièdric. Introducció	FIGURA 39	EXERCICI 7
NOM	DATA	NOTA	

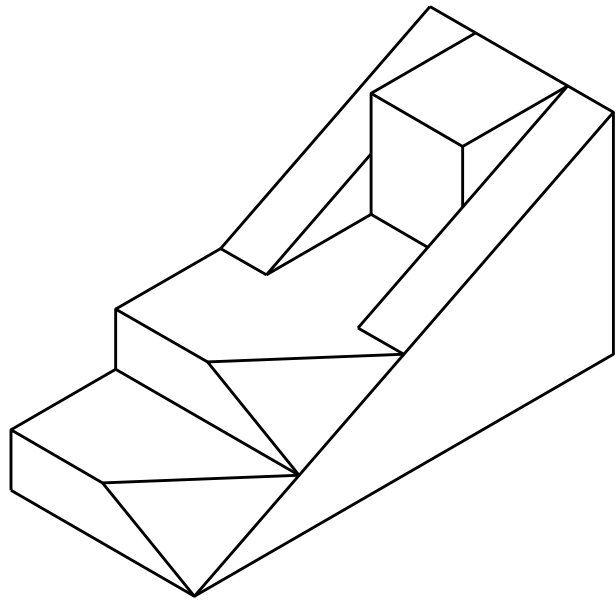

U7

El sistema dièdric. Introducció

FIGURA
40

EXERCICI
7

NOM

DATA

NOTA



u

A''
A'

U7

El sistema dièdric. Introducció

FIGURA
41

EXERCICI
8

NOM

DATA

NOTA

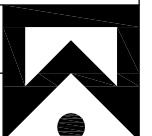

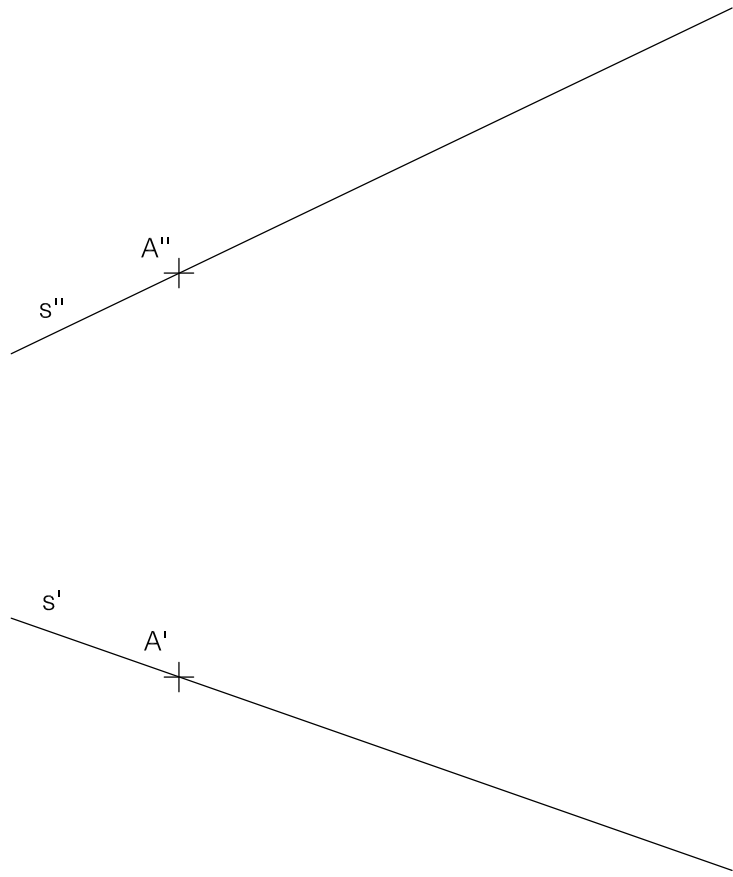

U7	El sistema dièdric. Introducció	FIGURA 42	EXERCICI 9
NOM	DATA	NOTA	

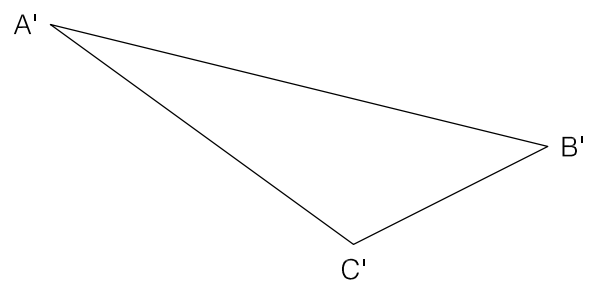
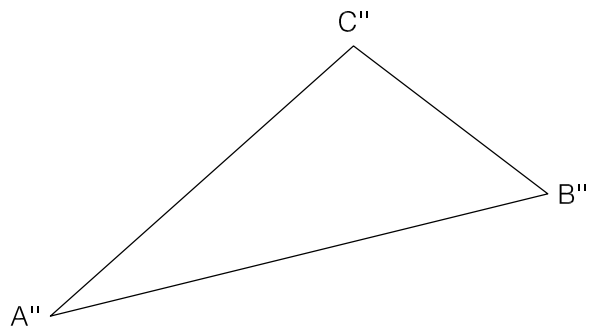



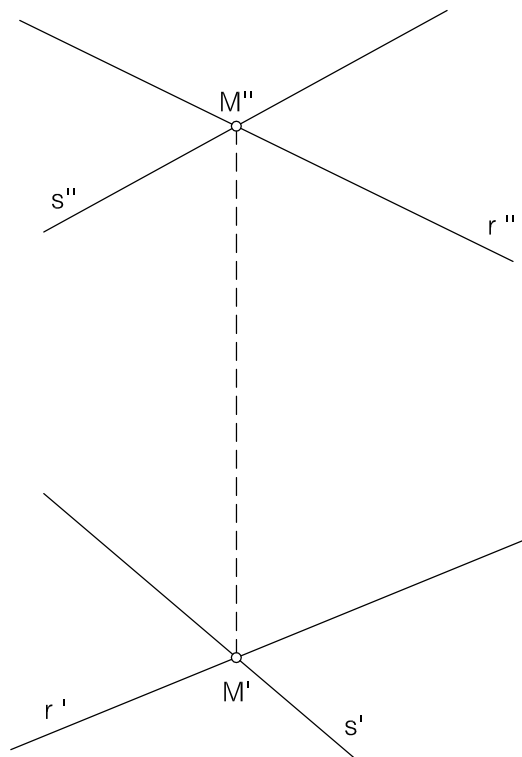

U7	El sistema dièdric. Introducció	FIGURA 43	EXERCICI 10
NOM	DATA	NOTA	

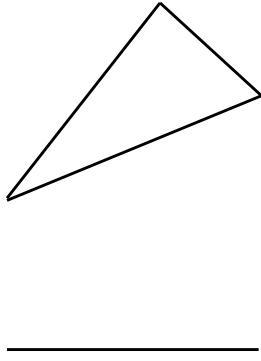
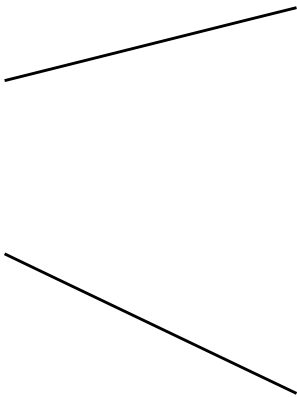

U7	El sistema dièdric. Introducció	FIGURA 44	EXERCICI 11
NOM		DATA	NOTA

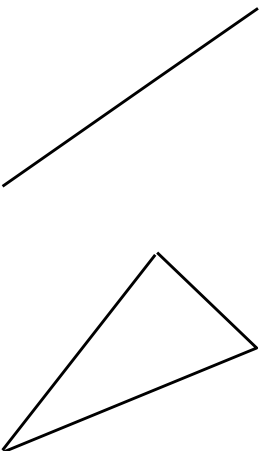
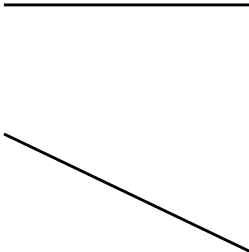
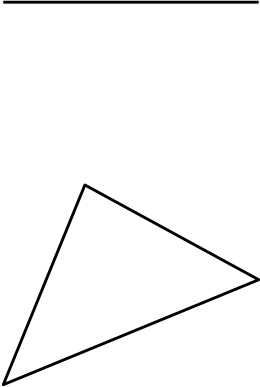

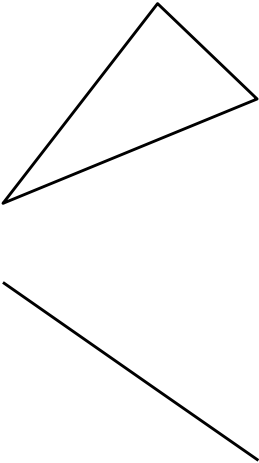
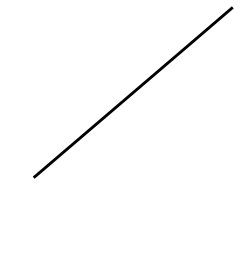
U7

El sistema dièdric. Introducció

FIGURA
45

EXERCICI
12

NOM

DATA

NOTA

